





OCCAP | GROUP

Trucks

INDICE – CONTENTS

	PAGINA - PAGE
IMPIEGO DEL CATALOGO - HOW TO USE THE CATALOGUE	A-2
DESCRIZIONE DEI PARTICOLARI – ITEMS DESCRIPTION	A-3
ASTRA	1-1
DAF	2-1
HYUNDAI	3-1
IVECO	4-1
MAN	5-1
MERCEDES	6-1
NISSAN	7-1
RENAULT V.I.	8-1
SCANIA	9-1
VOLVO	10-1
CORRISPONDENZE CODICI - CROSS REFERENCE	
CODICE ORIGINALE > CODICE OCAP ORIGINAL NUMBER > OCAP NUMBER	11-1
CODICE OCAP > CODICE ORIGINALE OCAP NUMBER > ORIGINAL NUMBER	12-1

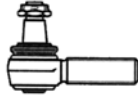
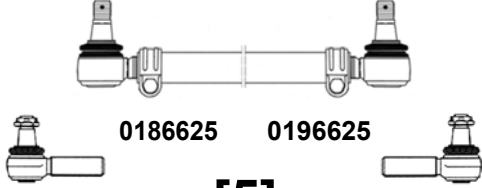
IMPIEGO DEL CATALOGO - HOW TO USE THE CATALOGUES

RIF. ORIG O.E. NUMBER	RIF. ORIG O.E. NUMBER	NOTE REMARKS	MODELLO/DESCRIZIONE MODEL/DESCRIPTION
0186622 [1] 	42493781 2966688 [2]	M=30x1,5 RHT L= 115 m=20x1,5	EUROCARGO: 120E15/E18/E23 130E15/E18/E23 150E15/E23/E27 R 260E23T-280E23T 320E27T
0186622  0186625 0196625 [5]	98458724 98427667	L=1636 [3]	EUROTECH: 180E24/27/30 190E24/27/30 400E30/34 [4]
0600918 	3812A4 9566950880	M=14x1,5 RHT	SNODO ASSIALE – AXIAL JOINT

	I	GB	D	F	E
[1]	Riferimento OCAP	OCAP References	OCAP Nummern	Références OCAP	Referencias OCAP
[2]	Riferimento originale	Original number	Originalnummern	Numero original	Numero original
[3]	Note	Remarks	Bemerkungen	Remarques	Observaciones
[4]	Modello/Descrizione	Model/Description	Modell/Beschreibung	Modell/Description	Modelo/Descripción
[5]	Teste di ricambio	Tie rod ends	Kugelgelenk	Rotules	Ròtulas

FABBRICANTI, MARCHE E CODICI PRODOTTI SONO ELENCATI SOLO PER L'IDENTIFICAZIONE DEL VEICOLO PER CUI I PARTICOLARI SONO ADATTI

ALL VEHICLE MANUFACTURES NAMES AND ORIGINAL PART NUMBER IN THIS CATALOG ARE FOR REFERENCE PURPOSES ONLY





DIE GENANNTEN ORIGINAL NRN. DIENEN NUR ZU VERGLEICHSZWECKEN

LE NOMS DES FABRICANTS DE VEHICULES AINSI QUE LES NUMEROS DE PIECES INDIQUES DANS CE CATALOGUE DOIVENT ETRE UTILISES UNIQUEMENT COMME REFERENCES

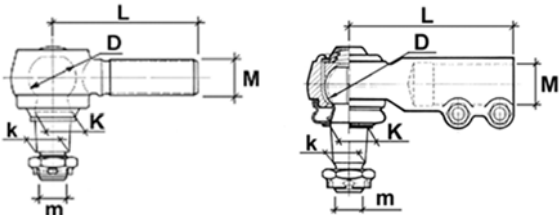
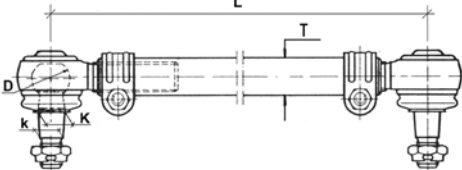
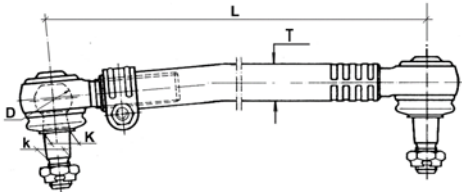
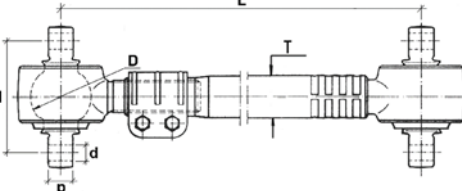
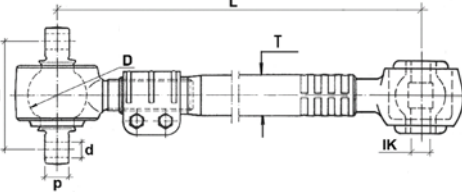
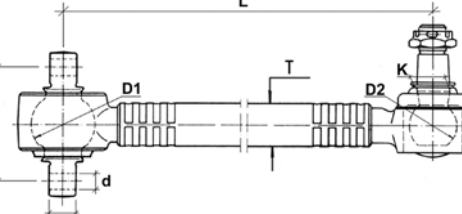
TODOS LAS DENOMINACIONES DE FABRICANTES Y NUMEROS DE PIEZAS ORIGINALES INDICADOS EN ESTE CATALOGO SON UNICAMENTE PARA USO DE CONPARACION

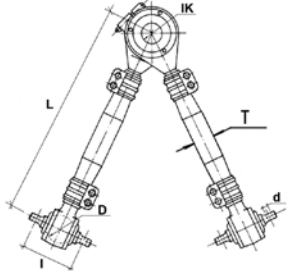
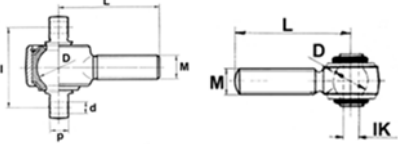
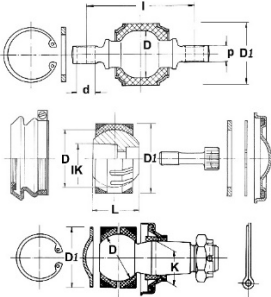
DESCRIZIONE DEI PARTICOLARI - ITEMS DESCRIPTION

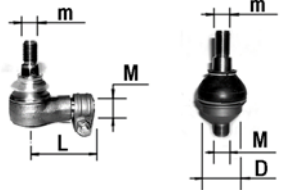

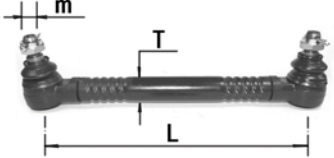

<p style="text-align: center;">Testa / Tie rod end</p> 	<p>M = Filetto gambo - Shank thread m = Filetto perno - Pin thread L = Lunghezza testa sterzo – Tie rod end length D = Diametro sfera - Ball pin diameter K = Diametro cono base perno - Taper diameter max. size k = Diametro cono inizio perno - Taper diameter min. size</p>
<p style="text-align: center;">Barra accoppiamento / Tie rod</p> 	<p>L = Lunghezza barra accoppiamento – Tie rod length D = Diametro sfera - Ball pin diameter K = Diametro cono base perno - Taper diameter max. size k = Diametro cono inizio perno - Taper diameter min. size T = Diametro tubo - Tube diameter</p>
<p style="text-align: center;">Tirante longitudinale / Drag link</p> 	<p>L = Lunghezza tirante – Drag link length D = Diametro sfera - Ball pin diameter K = Diametro cono base perno - Taper diameter max. size k = Diametro cono inizio perno - Taper diameter min. size T = Diametro tubo - Tube diameter</p>
<p style="text-align: center;">Barra di reazione / Torque rod</p> 	<p>L = Lunghezza barra di reazione – Torque rod length D = Diametro sfera - Ball pin diameter d = Diametro foro perno - Hole pin diameter p = Spessore perno – Thickness of the pin I = Interasse fori perno - Pin hole spacing T = Diametro tubo - Tube diameter</p>
<p style="text-align: center;">Barra reazione / Torque rod</p> 	<p>L = Lunghezza barra di reazione – Torque rod length D = Diametro sfera - Ball pin diameter d = Diametro foro perno - Hole pin diameter p = Spessore perno - Thickness of the pin I = Interasse fori perno - Pin hole spacing IK = Diametro foro sfera - Hole ball pin diameter T = Diametro tubo - Tube diameter</p>
<p style="text-align: center;">Barra reazione / Torque rod</p> 	<p>L = Lunghezza barra di reazione – Torque rod length D1 = Diametro sfera - Ball pin diameter D2 = Diametro sfera - Ball pin diameter K = Diametro cono base perno - Taper diameter max. size d = Diametro foro perno - Hole pin diameter p = Spessore perno - Thickness of the pin I = Interasse fori perno - Pin hole spacing T = Diametro tubo - Tube diameter</p>

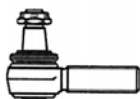
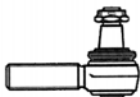
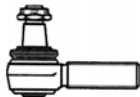
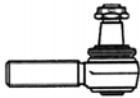
<p>Barra reazione triangolare/ Triangular torque rod</p> 	<p>L = Lunghezza barra di reazione – Torque rod length D = Diametro sfera - Ball pin diameter d = Diametro foro perno - Hole pin diameter p = Spessore perno - Thickness of the pin l = Interasse fori perno - Pin hole spacing IK = Diametro foro sfera - Hole ball diameter T = Diametro tubo - Tube diameter T = Diametro tubo - Tube diameter</p>
<p>Testa barra / Ball joint</p> 	<p>L = Lunghezza testa – Ball joint length M = Filetto gambo testa - Head shank thread D = Diametro sfera - Ball pin diameter d = Diametro foro perno - Hole pin diameter p = Spessore perno - Thickness of the pin l = Interasse fori perno - Pin hole spacing IK = Diametro foro sfera - Hole ball diameter</p>
<p>Kit riparazione / Repair kit</p> 	<p>D = Diametro sfera - Ball pin diameter D1 = Diametro kit – Kit diameter d = Diametro foro perno - Hole pin diameter p = Spessore perno - Thickness of the pin l = Interasse fori perno - Pin hole spacing K = Diametro cono base perno - Taper diameter max. size IK = Diametro foro sfera - Hole ball pin diameter L = Lunghezza sfera - Ball pin length</p>
<p>Snodo assiale / Axial joint</p> 	<p>L = Lunghezza snodo assiale – Axial joint length M = Filetto perno - Pin thread m = Filetto corpo - Shape thread</p>
<p>Snodo sospensione / Ball joint</p> 	<p>M = Filetto snodo sospensione - Ball joint thread m = Filetto perno - Pin thread L = Lunghezza da centro testa a fine gambo - Length from head center to end of stick D = Diametro sfera - Ball pin diameter</p>
<p>Braccio oscillante / Track control arm</p> 	
<p>Stabilizzatore / Stabilizer link</p> 	<p>L = Lunghezza stabilizzatore – Stabilizer link length m = Filetto perno - Pin thread T = Diametro tubo - Tube diameter</p>

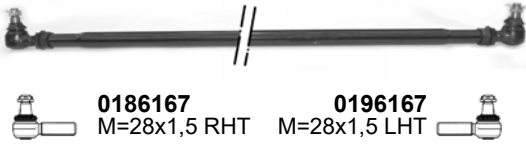
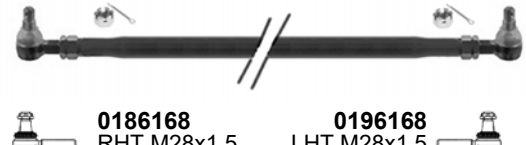

TESTE STERZO - TIE RODS END

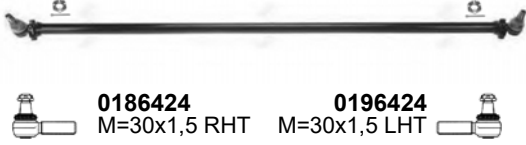
RIF. OCAP OCAP REF.	RIF. ORIG O.E. NUMBER	NOTE REMARKS	MODELLO / DESCRIZIONE MODEL / DESCRIPTION
0186421 	10229	L=125 M=38x1,5 RHT	BM
0196421 	30042	L= 125 M=38x1,5 LHT	BM
0186422 	101347 113251	L=135 M=38x1,5 RHT	BM
0196422 	101348 113252	L= 135 M=38x1,5 LHT	BM



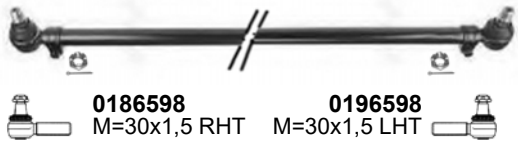

BARRE ACCOPPIAMENTO - TIE RODS

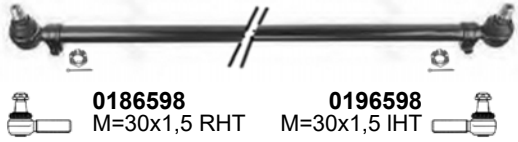
RIF. OCAP OCAP REF.	RIF. ORIG O.E. NUMBER	NOTE REMARKS	MODELLO / DESCRIZIONE MODEL / DESCRIPTION
<p>0506167</p>  <p>0186167 M=28x1,5 RHT 0196167 M=28x1,5 LHT</p>	<p>9703300003 9703300103 9703300203 9703300303 9703300403 HJK3892</p>	L=1475	
<p>0506168</p>  <p>0186168 RHT M28x1,5 0196168 LHT M28x1,5</p>	1407963	L=1640	45 LF
<p>0506432</p>  <p>0186424 M=30x1,5 RHT</p>	1286343	T=52 L=1698	CF 75 - 85 XF 95 - 105
<p>0507933</p>  <p>0186424 M=30x1,5 RHT 0196424 M=30x1,5 LHT</p>	1270853 1353391	T=40 L=1698	CF 65 - 75 - 85 XF 95 - 105
<p>0507934</p>  <p>0186424 M=30x1,5 RHT 0196424 M=30x1,5 LHT</p>	1337644 0288281 288281 1270854	T=40 L=1734	CF 65 - 75 - 85 + XF 95 - 105
<p>0507942</p>  <p>0187843 M=30x1,5 RHT</p>	1297572 1361155	T=52 L=1522	CF 75 - 85 XF 95 - 105



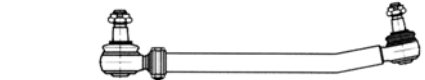

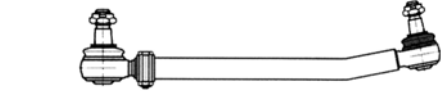

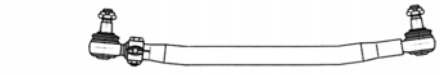
BARRE ACCOPPIAMENTO - TIE RODS

RIF. OCAP OCAP REF.	RIF. ORIG O.E. NUMBER	NOTE REMARKS	MODELLO / DESCRIZIONE MODEL / DESCRIPTION
<p>0507949</p>  <p>0186598 0196598 M=30x1,5 RHT M=30x1,5 LHT</p>	1700000	T=40 L=1690	CF 65 - 75 - 85 XF 95 - 105
<p>0509438</p>  <p>0187894 M=30x1,5 RHT</p>	1732973	T=52 L=1698	CF 75 - 85 XF 105
<p>0509469</p>  <p>0186598 0196598 M=30x1,5 RHT M=30x1,5 LHT</p>	1807596	T=40 L=1766	XF FA-FAD-FAR-FAS-FT-FTP-FTR-FTS

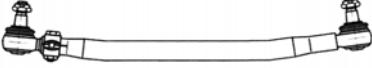









TIRANTI LONGITUDINALI - DRAG LINKS

RIF. OCAP OCAP REF.	RIF. ORIG O.E. NUMBER	NOTE REMARKS	MODELLO / DESCRIZIONE MODEL / DESCRIPTION
<p>0506417</p>  <p>0187723 M=24x1,5 RHT</p>	<p>HJK3891</p>	<p>T=50 L=1685</p>	<p>45 LF</p>
<p>0506429</p>  <p>0186758 M=30x1,5 RHT</p>	<p>94029 0117343</p>	<p>L=872</p>	<p>F 95 - F 2300-F 2800 F 3300-F 3600</p>
<p>0506430</p>  <p>0186598 M=30x1,5 RHT</p>	<p>0094038 0554765 094038 554765 94038 525443</p>	<p>T=52 L=995</p>	<p>95 XF</p>
<p>0506431</p>  <p>0186758 M=30x1,5 RHT</p>	<p>94016 0171215</p>	<p>L=744</p>	<p>F 95 - F 2100-F 2300-F 2500-F 2700</p>
<p>0506433</p>  <p>0186424 M=30x1,5 RHT</p>	<p>1291060 1385499 1351734</p>	<p>T=52 L=1005</p>	<p>XF 95</p>
<p>0506434</p>  <p>0186424 M=30x1,5 RHT</p>	<p>1283212 1247957 1385492</p>	<p>T=52 L=848</p>	<p>F 75 - 65 CF - 75 CF - 85 CF -75 XF CF 75 - CF 85</p>



TIRANTI LONGITUDINALI - DRAG LINKS

RIF. OCAP OCAP REF.	RIF. ORIG O.E. NUMBER	NOTE REMARKS	MODELLO / DESCRIZIONE MODEL / DESCRIPTION
<p>0506435</p>  <p>0186424 M=30x1,5 RHT</p>	<p>1283211 1247956 1385497 1351714</p>	<p>T=52 L=876</p>	<p>CF 75 - CF 85 - F 75- F 85 65 CF - 75 CF - 85 CF 75 XF- 85 XF</p>
	<p>1451122 139264</p>	<p>T=52 L=1977</p>	<p>CF 75 - CF 85</p>
<p>0507937</p>  <p>0186598 M=30x1,5 RHT 0196598 M=30x1,5 LHT</p>	<p>1451118</p>	<p>T=38 L=860</p>	<p>CF 75 - 85 - XF 95 - 105</p>
<p>0507938</p>  <p>0186598 M=30x1,5 RHT</p>	<p>1451129 1380417</p>	<p>T=36 L=860</p>	<p>CF 75 - CF 85</p>
<p>0507947</p>  <p>0186598 M=30x1,5 RHT</p>	<p>1395994</p>	<p>T=50 L=991</p>	<p>CF 85 XF 95 - 105</p>
<p>0507948</p>  <p>0186598 M=30x1,5 RHT</p>	<p>1602821 1448063 1363859</p>	<p>T=50 L=867</p>	<p>CF 65 - 75 - 85</p>







TIRANTI LONGITUDINALI - DRAG LINKS

RIF. OCAP OCAP REF.	RIF. ORIG O.E. NUMBER	NOTE REMARKS	MODELLO / DESCRIZIONE MODEL / DESCRIPTION
0509459   0186598 M=30x1,5 RHT	1902942 1828523	T=52 L=785	CF - XF
0509464   0186598 M=30x1,5 RHT	1448064 1373878	T=52 L=865	CF 75 - 85
0509474   0186598 M=30x1,5 RHT	1426101	T=52 L=1004	CF 85 XF 95-105
0509939   0197928 M=30x1,5 LHT	1700913 14066	T=38 L=900	LF 45
0509941  0196424 M=30x1,5 LHT 	1401937	T=40 L=910	LF 55
0509943 	1405309 1403898	T=46 L=926	CF 65 - LF 55

TIRANTI LONGITUDINALI - DRAG LINKS

RIF. OCAP OCAP REF.	RIF. ORIG O.E. NUMBER	NOTE REMARKS	MODELLO / DESCRIZIONE MODEL / DESCRIPTION
<p>0509946</p>  <p>0186598 M=30x1,5 RHT</p>	<p>1395993</p>	<p>T=38 L=996</p>	<p>XF 95 - 105</p>
<p>0509947</p>  <p>0186598 M=30x1,5 RHT</p>	<p>1395995</p>	<p>T=52 L=1000</p>	<p>XF 95 - 105</p>



TESTE STERZO - TIE RODS END

RIF. OCAP OCAP REF.	RIF. ORIG O.E. NUMBER	NOTE REMARKS	MODELLO / DESCRIZIONE MODEL / DESCRIPTION
0186168 	1604248 1705907 1902997 1703472	L=150 M=28x1,5 RHT	LF 45
0186424 	1331925 698609 607999 1229944 1326896	L=115 M=30x1,5 RHT	CF 65 - 75 M 2000 XF 95 - 105
0186598 	688450 607981 257890 1149907 1152350 1257890 1603789 1618048 ACHF060	L=120 M=30x1,5 RHT	CF 65 - 75 - 85 XF 95
0196598 	1228115 696225 607053 1329134 1611088 696205	L=120 M=30x1,5 LHT	CF 65 - 75 - 85 XF 95
0186613 	1373135 1743554 607451 ACU9242 0110197	L=105 M=28x1,5 RHT	CF 65 - 75 - 85 XF 95
0196613 	1743594 1373137 607452	L=105 M=28x1,5 LHT	CF 65 - 75 - 85 XF 95
0186758 	696226 607073	L=135 M=30x1,5 RHT	CF 65 - 75 - 85
0187723 	1603883 1149875	L=150 M=30x1,5 RHT	LF 45 - 55





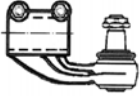
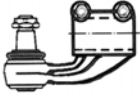
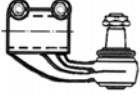
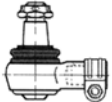

TESTE STERZO - TIE RODS END

RIF. OCAP OCAP REF.	RIF. ORIG O.E. NUMBER	NOTE REMARKS	MODELLO / DESCRIZIONE MODEL / DESCRIPTION
0187803 	ACU9240 AFRA888	L=180 M=28x1,5 RHT	45 FA
0197803 	ACU9239	L=180 M=28x1,5 LHT	45 FA
0188994 	1685552	L=140 M=30x1,5 RHT	CF 65 - 75 - 85 LF 55 XF 95 - 105
0196168 	1604247 1703473 1902296 1705908	L=150 M=28x1,5 LHT	LF 45
0196424 	1319838 607998 1315447 ACHF241 1332123 311300	L=115 M=30x1,5 LHT	CF 65 - 75
0196608 	1689605	L=115 M=28x1,5 LHT	LF 45
0197928 	1401942 AFRA635	L=120 M=30x1,5 LHT	LF 45 - LF FA
0286427 	606923	L=130 M=46x1,5 RHT	95 XF F 95/1600/1700/1900 F 2000/2100/2105/2200 F 2300/ 2305/2500/2505/2600 F 2700/2800/2900 F 3200/3300/3305/3600 TT 2100

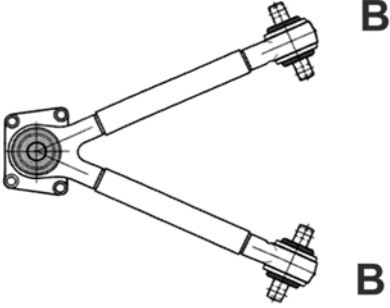

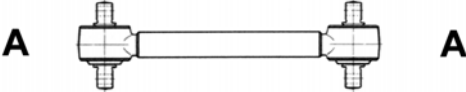

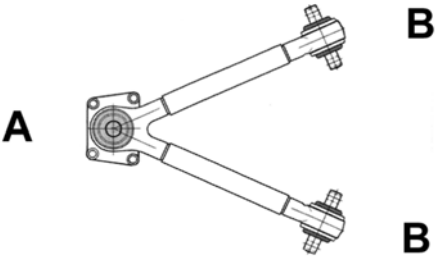

TESTE STERZO - TIE RODS END

RIF. OCAP OCAP REF.	RIF. ORIG O.E. NUMBER	NOTE REMARKS	MODELLO / DESCRIZIONE MODEL / DESCRIPTION
0296427 	606922	L=130 M=46x1,5 LHT	95 XF F 95/1600/1700/1900 F 2000/2100/2105/2200 F 2300/ 2305/2500/2505/2600 F 2700/2800/2900 F 3200/3300/3305/3600 TT 2100
0286428 	67389	L=130 M=48x1,5 RHT	65 CF - 75 CF - 85 CF
0296428 	67303	L=130 M=48x1,5 LHT	65 CF - 75 CF - 85 CF
0287291 	8178244	L=95 M=24x1,5 RHT	LF 55
0287503 	273203 1399724	L=95 M=22x1,5 RHT	CF 75-85 + XF 95

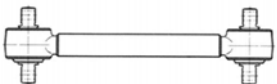
BARRE DI REAZIONE - TORQUE RODS

RIF. OCAP OCAP REF.	RIF. ORIG O.E. NUMBER	NOTE REMARKS	MODELLO / DESCRIZIONE MODEL / DESCRIPTION
<p>0807489</p>  <p>0907489</p> 	<p>0080521 1793875 1390932 1368270 1361651</p> <p>0698724</p>	<p>T=48 L=608</p> <p>d=23</p> <p>d=23 L=152 p=24 D=70</p>	<p>CF 65 - 75 -85</p>
<p>0807501</p>  <p>0907359</p> 	<p>1361649 1361650 1656428 1817809 1663207 0267743</p> <p>513757 0691709</p>	<p>T=48 L=605</p> <p>d=21</p> <p>p=30 l=130 D=70 d=21</p>	<p>CF 75 - 85 LF 55 XF 95 - 105</p>
<p>0807525</p>  <p>0907525</p> 	<p>0649819 1620437 1793877</p> <p>0696320</p>	<p>T=58 L1=550 d=23 L2=550</p> <p>L=61 IK=56 D=80</p>	<p>CF 75 - 85 XF 95 - 105</p>







BARRE DI REAZIONE - TORQUE RODS

RIF. OCAP OCAP REF.	RIF. ORIG O.E. NUMBER	NOTE REMARKS	MODELLO / DESCRIZIONE MODEL / DESCRIPTION
<p>0907529</p> <p>B</p> 	0696321	<p>p=35 l=152 D=95 d=23</p>	
<p>0807555</p>  <p>B</p>	1261101	<p>T=50 L=390</p> <p>d1=21 - d2=19</p>	<p>CF 75 - 85 XF 95 - 105</p>
<p>0907258</p> <p>B</p> 	<p>1271124 2980884 81432206132 81432206108</p>	<p>p=30 l=130 D=65 d=19</p>	
<p>0807927</p> <p>A</p>  <p>A</p>	1294251	<p>T=42 L=606</p>	CF 75 - 85
<p>0907927</p> <p>A</p> 	1321936	<p>p=24</p> <p>D=67 d=19</p>	
<p>0807930</p> <p>A</p>  <p>B</p> <p>B</p>	<p>1793876 1620436 1361652</p>	<p>T=48 L=608,2</p> <p>d=23</p>	CF 75 - 85
<p>0907525</p> <p>A</p> 	0696320	<p>L=61 IK=56 D=80</p>	

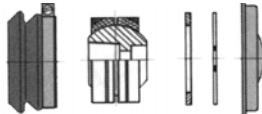
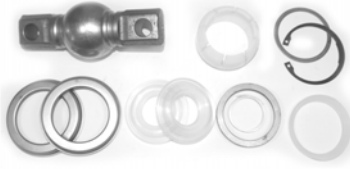

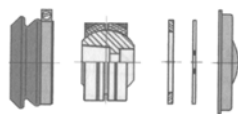

BARRE DI REAZIONE - TORQUE RODS

RIF. OCAP OCAP REF.	RIF. ORIG O.E. NUMBER	NOTE REMARKS	MODELLO / DESCRIZIONE MODEL / DESCRIPTION
<p>0907489</p> <p>B </p>	<p>0698724</p>	<p>d=23 L=152 p=24 D=70</p>	

KIT DI SOSPENSIONE - SUSPENSION KITS

RIF. OCAP OCAP REF.	RIF. ORIG O.E. NUMBER	NOTE REMARKS	MODELLO / DESCRIZIONE MODEL / DESCRIPTION
0907257 	1398368 0691704 0069600	IK=38 L=50 D=65	CF 65 - 75 - 85 LF 55 XF 95
0907258 	1271124 2980884 81432206132 81432206108	p=30 l=130 D=65 d=19	CF 75 - 85 XF 95 - 105
0907296 	1252284	p=24 l=130 D=75 d=21	CF 85
0907297 	1376730	IK=38 D=65	CF 65 - 75 - 85 XF 95
0907359 	513757 0691709	p=30 l=130 D=70 d=21	CF 75 - 85 - 95 LF 55 XF 95 - 105
0907489 	0698724	d=23 L=152 p=24 D=70	CF 65 - 75 -85 LF 55 XF 95 - 105
0907525 	0696320	L=61 IK=56 D=80	CF 75 - 85 XF 95 - 105
0907528 	0689748	p=24 l=115 D=75 d=17	CF 75 - 85 - 95 XF 95

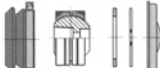

KIT DI SOSPENSIONE - SUSPENSION KITS

RIF. OCAP OCAP REF.	RIF. ORIG O.E. NUMBER	NOTE REMARKS	MODELLO / DESCRIZIONE MODEL / DESCRIPTION
0907529 	0696321	p=35 l=152 D=95 d=23	CF 65 - 75 - 85 XF 95 - 105
0907595 	0693778		CF 75 - 85 XF 95 - 105
0907683 	0696320		CF 75 - 85 XF 95 - 105
0907757 	1271124	D=65	CF 75 - 85 XF 95 - 105
0907927 	1321936	p=24 D=67 d=19	CF 75 - 85











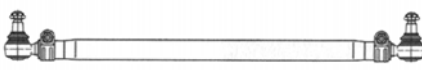

TESTE COMANDO CAMBIO - GEAR BOX CONTROL BALL JOINTS

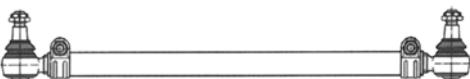
RIF. OCAP OCAP REF.	RIF. ORIG O.E. NUMBER	NOTE REMARKS	MODELLO / DESCRIZIONE MODEL / DESCRIPTION
0187228 	386930 0386930 542477	L=85 M=14x1,5 RHT	95 XF - F

TESTE STERZO - TIE RODS END

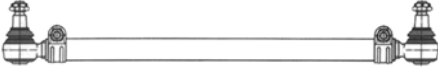
RIF. OCAP OCAP REF.	RIF. ORIG O.E. NUMBER	NOTE REMARKS	MODELLO / DESCRIZIONE MODEL / DESCRIPTION
0187922 	-	L=100 M=22x1,5 RHT	H65
0197922 	-	L=100 M=22x1,5 LHT	H65

BARRE ACCOPPIAMENTO - TIE RODS

RIF. OCAP OCAP REF.	RIF. ORIG O.E. NUMBER	NOTE REMARKS	MODELLO / DESCRIZIONE MODEL / DESCRIPTION
0506542   0186608 0196608 M=28x1,5 RHT M=28x1,5 LHT	7166384	L=1455	115.14/.17 135.14/.17 145.17
0506613   0186613 0196613 M=28x1,5 RHT M=28x1,5 LHT	60103171	L=1346	90-17WM 75-13 AWM
0506788   0186424 0196424 M=30x1,5 RHT M=30x1,5 LHT	42026853 247605	L=1603	130-13 AH 130-16 AH 150-16 AN
0506817   0186598 0196598 M=30x1,5 RHT M=30x1,5 LHT	98458724 9842766	L=1636	EUROTECH: 180E24/27/30 190E24/27/30 400E30/34
0506827   0186424 0196424 M=30x1,5 RHT M=30x1,5 LHT	86011651 42037384 86018015 42064639	L=1506	110-13A/AH 110-16A/AH/AT 130-13A/AH 130-16A/AH 130M11FL
0506847   0186598 0196598 M=30x1,5 RHT M=30x1,5 LHT	42003432 41036943 41042938	T=46 L=1640	TURBOSTAR TURBOTECH



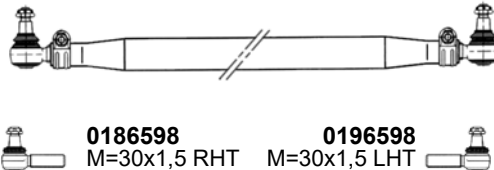
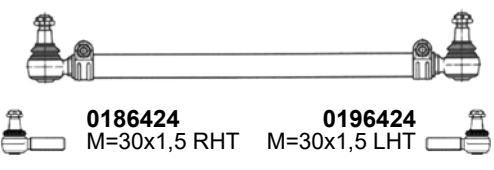
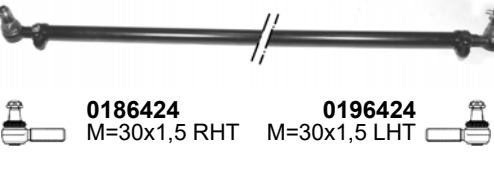
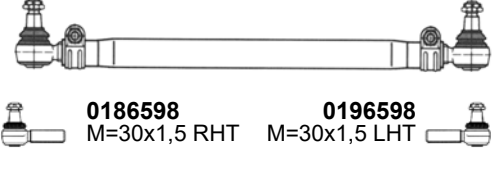
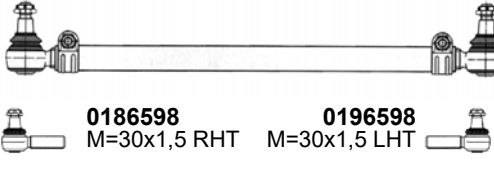

BARRE ACCOPPIAMENTO - TIE RODS

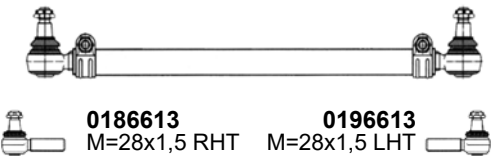
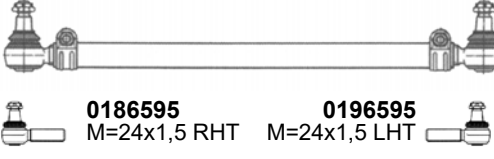
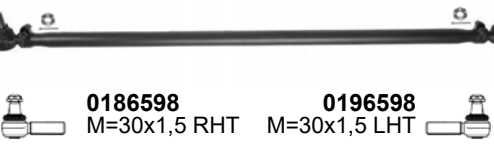
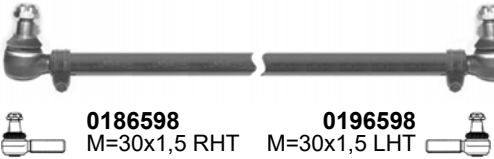
RIF. OCAP OCAP REF.	RIF. ORIG O.E. NUMBER	NOTE REMARKS	MODELLO / DESCRIZIONE MODEL / DESCRIPTION
<p>0506904</p>  <p>0186613 M=28x1,5 RHT 0196613 M=28x1,5 LHT</p>	<p>86012923 42037386 7166166</p>	<p>L=1404</p>	<p>80.13 - 80.16 - 90.13</p>
<p>0506932</p>  <p>0186598 M=30x1,5 RHT 0196598 M=30x1,5 LHT</p>	<p>41005450 8163773 41005451 41036944 41042730</p>	<p>T=48 L=1641</p>	<p>EUROTECH EUROSTAR CURSOR EUROTRAKKER CURSOR TRAKKER STRALIS</p>
<p>0506950</p>  <p>0186424 M=30x1,5 RHT 0196424 M=30x1,5 LHT</p>	<p>98402553 5003075</p>	<p>T=38 L=1490</p>	<p>EUROCARGO - EUROCARGO TECTOR</p>
<p>0506953</p>  <p>0186424 M=30x1,5 RHT 0196424 M=30x1,5 LHT</p>	<p>4854871</p>	<p>T=42 L=1584</p>	<p>EUROCARGO - EUROCARGO TECTOR</p>
<p>0506994</p>  <p>0186598 M=30x1,5 RHT 0196598 M=30x1,5 LHT</p>	<p>98470968</p>	<p>T=42 L=1590</p>	<p>EUROCARGO I-III</p>
<p>0507288</p>  <p>0186598 M=30x1,5 RHT 0196598 M=30x1,5 LHT</p>	<p>8165309</p>	<p>T=48 L=1560</p>	<p>EUROCARGO EUROTRAKKER - EUROTRAKKER CURSOR TRAKKER</p>



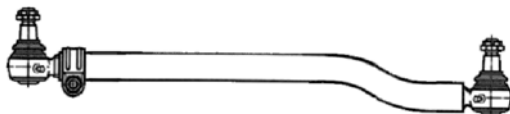



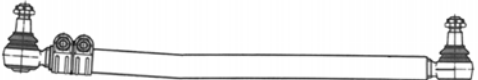



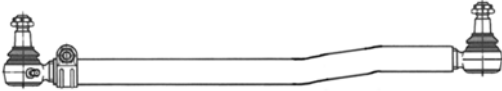

BARRE ACCOPPIAMENTO - TIE RODS

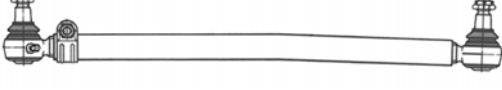
RIF. OCAP OCAP REF.	RIF. ORIG O.E. NUMBER	NOTE REMARKS	MODELLO / DESCRIZIONE MODEL / DESCRIPTION
0507290  0186613 M=28x1,5 RHT 0196613 M=28x1,5 LHT	8582320 8564386	T=34 L=1348	GAMMA ZETA
0507323  0186595 M=24x1,5 RHT 0196595 M=24x1,5 LHT	86012924	L=1424	MK: 75-9A/H 80-9A/AH
0507366  0186598 M=30x1,5 RHT 0196598 M=30x1,5 LHT	41033237 410326	T=48 L=1477	EUROTECH EUROSTAR STRALIS TRAKKER
0509421  0186598 M=30x1,5 RHT 0196598 M=30x1,5 LHT	504144266 580169	T=42 L=1620	EUROCARGO I - II - III









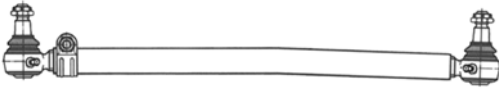

TIRANTI LONGITUDINALI - DRAG LINKS

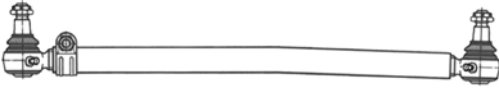
RIF. OCAP OCAP REF.	RIF. ORIG O.E. NUMBER	NOTE REMARKS	MODELLO / DESCRIZIONE MODEL / DESCRIPTION
<p>0506709</p>  <p>0196603 M=25x1,5 LHT</p>	<p>4665085 4626917</p>	<p>Lt=775</p>	<p>100NC-110NC e deriv. 645N2/N3 650N2/N3 655N/N1 662N2/N3/T-672N</p>
<p>0506710</p>  <p>0196603 M=25x1,5 LHT</p>	<p>4665209</p>	<p>L=798</p>	<p>100NC-110NC 662N3/T-672N veicoli con servosterzo (vehicles with power steering)</p>
<p>0506711</p>  <p>0186604 M=28x1,5 RHT</p>	<p>4665501</p>	<p>L=782</p>	<p>673N/T 130NC/NR/NT veicolo a cabina fissa (vehicle with fixed compartment)</p>
<p>0506712</p>  <p>0186605 M=38x1,5 RHT</p>	<p>4520694 4669091</p>	<p>L=517</p>	<p>180NC/NT/NTS 690N1//N2/N3/N4/T2 691N/T/TS</p>
<p>0506716</p>  <p>0186599 M=38x1,5 RHT</p>	<p>4699246</p>	<p>L=976</p>	<p>170NC26-170NC33 170NT26-170NT33 170NC35-170NT35 190NC26-190NC33 190NT26-190NT33 190NC35-190NT35</p>
<p>0506717</p>  <p>0186599 M=38x1,5 RHT</p>	<p>4699305</p>	<p>L=975</p>	<p>170NC26-170NC33 170NT26-170NT33 170NC35-170NT35 190NC26-190NC33 190NT26-190NT33 190NC35-190NT35 guida DX (RH drive)</p>

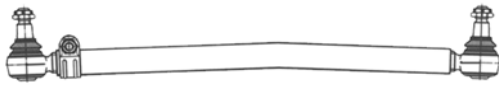

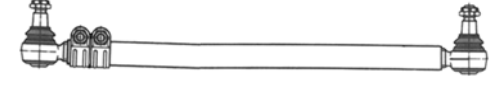





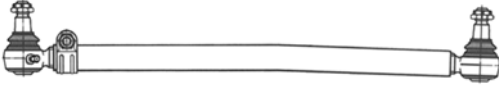

TIRANTI LONGITUDINALI - DRAG LINKS

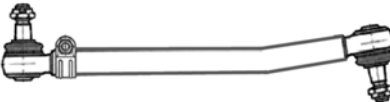
RIF. OCAP OCAP REF.	RIF. ORIG O.E. NUMBER	NOTE REMARKS	MODELLO / DESCRIZIONE MODEL / DESCRIPTION
0506720   0186605 M=38x1,5 RHT	4624032 4732546 4666954	L=915	300PC/PT 619NI/NIP/TI/TIP 697N/NP/T/TP
0506721   0186605 M=38x1,5 RHT	4667156 4732549 4624116	Lt=855	300PC/PT 619NI/NIP/TI/TIP 697N/NP/T/TP
0506723   0186605 M=38x1,5 RHT	4666933 4733752 4666993	L=906	160NC/R 684N/NP/T/TP
0506726   0186612 M=24x1,5 RHT	8591222 8590479 8558522	T=30 L=830	GAMMA ZETA
0506736   0186608 M=28x1,5 RHT	8567618 8582350 8567619	L=755	con s/sterzo e cabina fissa (with power steering and fixed cab) 50.8-50.10/F10 60.10/F10-65.10/F10 65.9Z-79.10-79.13-79.14 90.13/F13 ZETA
0506737   0186612 M=24x1,5 RHT	8591219 8564248 8590443	T=30 L=765	GAMMA ZETA





TIRANTI LONGITUDINALI - DRAG LINKS

RIF. OCAP OCAP REF.	RIF. ORIG O.E. NUMBER	NOTE REMARKS	MODELLO / DESCRIZIONE MODEL / DESCRIPTION
0506738   0186603 M=25x1,5 RHT	8788387	Lt=825	100.13-100.F13 100EC-OMN100/10
0506740   0196603 M=25x1,5 LHT	8788641	L=885	100F13 OM 120-OMN 100
0506741   0186424 M=30x1,5 RHT	61590910	L=985	150NC17/20
0506743   0186599 M=38x1,5 RHT	61593332	Lt=937	159NC LHD 159NC 20
0506745   0186424 M=30x1,5 RHT	61595371	L=982	150NC 17 150NC 20
0506746 	61595960 6159082	L=1025	veicoli con cabina ribaltabile (vehicles with tilting cab) 130NC-NR-NT OM130/R/T



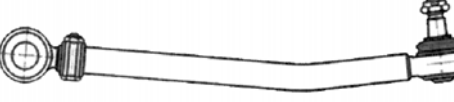

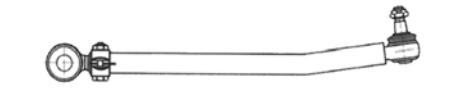





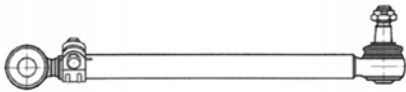

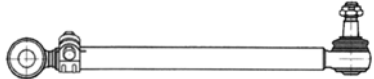
TIRANTI LONGITUDINALI - DRAG LINKS

RIF. OCAP OCAP REF.	RIF. ORIG O.E. NUMBER	NOTE REMARKS	MODELLO / DESCRIZIONE MODEL / DESCRIPTION
0506750   0186605 M=38x1,5 RHT	4666991 4733704	L=906	160NC/R 684N/NP/T/TP OM 160/T
0506753 	4520698 4669094	L=630	180NC/NT/NTS 690N1//N2/N3/N4/T2 691N/T/TS
0506812   0186424 M=30x1,5 RHT	8570528	L=708	con s/sterzo e cab.ribalt. (with power steering and tilting cab) ZETA: 50.9Z-65.9-79.14 TURBO ZETA: 60.11-65.12/H-79.12 60F10-60.10 79F10-79F13-79.10-79.13-79.14 90.13/F13
0506820   0186608 M=28x1,5 RHT	4834037 4773359	L=979	115-14 - 115-17 135-14 - 135-17 145-17 150 - 159-17
0506826   0186599 M=38x1,5 RHT	4793166 4834041	L=1001	165.24 175.17 175.24
0506839   0186599 M=38x1,5 RHT	4715615	L=975	160-26/26T 170.20 - 170-26/F26/F26T - 170-35 190.20 - 190-26/F26/F26T 190-35 - 190-38 240-26 - 240-35 TURBOTECH









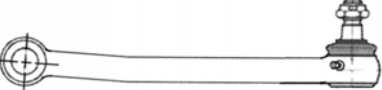
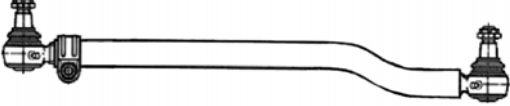

TIRANTI LONGITUDINALI - DRAG LINKS

RIF. OCAP OCAP REF.	RIF. ORIG O.E. NUMBER	NOTE REMARKS	MODELLO / DESCRIZIONE MODEL / DESCRIPTION
<p>0506840</p>  <p>0186598 M=30x1,5 RHT</p>	<p>42087842 4747961 4747960</p>	<p>T=48 L=982</p>	<p>TURBOSTAR TURBOTECH</p>
<p>0506848</p>  <p>0186598 M=30x1,5 RHT</p>	<p>42042950 4204391</p>	<p>L=910</p>	<p>190-26H/.30H 260-26H/30H/35H 330-26H/35H - 330-30H (1^ serie) 330-36 (1^ serie) (rinforzato-stiffened)</p>
<p>0506855</p>  <p>0186598 M=30x1,5 RHT</p>	<p>42001326 42001325 42086458</p>	<p>T=46 L=890</p>	<p>190</p>
<p>0506856</p>  <p>0186598 M=30x1,5 RHT</p>	<p>42043293 420439</p>	<p>L=796</p>	<p>160.23ANW 170.23AHW 190.25AN/ANT MAGIRUS</p>
<p>0506887</p>  <p>0186424 M=30x1,5 RHT</p>	<p>8590435</p>	<p>T=38 L=715</p>	<p>GAMMA ZETA</p>
<p>0506894</p>  <p>0186598 M=30x1,5 RHT</p>	<p>98446354</p>	<p>T=50 L=901</p>	<p>EUROTECH</p>



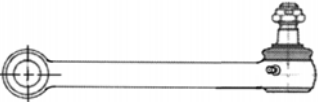
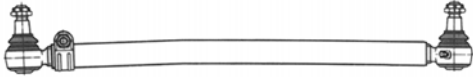

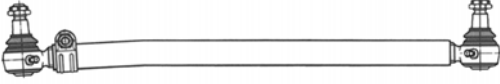





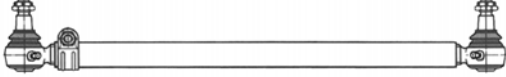

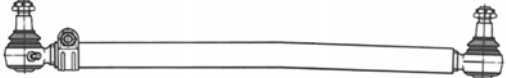
TIRANTI LONGITUDINALI - DRAG LINKS

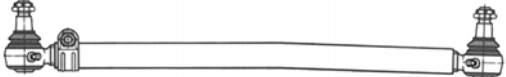
RIF. OCAP OCAP REF.	RIF. ORIG O.E. NUMBER	NOTE REMARKS	MODELLO / DESCRIZIONE MODEL / DESCRIPTION
0506897   0186598 M=30x1,5 RHT	41016958 8135446 41005472	T=52 L=832	STRALIS EUROSTAR
0506927   0186598 M=30x1,5 RHT	41016964 41005466 8136061 41017272	T=40 L=698	EUROTRAKKER
0506931   0186598 M=30x1,5 RHT	41005463 8131582 8132397 41042919	T=52 L=953	EUROTECH EUROSTAR EUROTRAKKER EUROTRAKKER CURSOR STRALIS TRAKKER
0506951   0186424 M=30x1,5 RHT	98402544 9846745	T=40 L=822	EUROCARGO
0506952   0186424 M=30x1,5 RHT	4854874	T=42 L=897	EUROCARGO
0506955   0186598 M=30x1,5 RHT	42118693 42117267 42118781	T=58 L=1458	EUROCARGO I - III



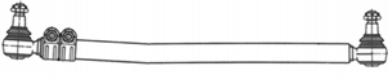

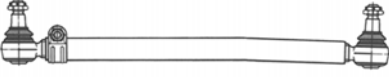
TIRANTI LONGITUDINALI - DRAG LINKS

RIF. OCAP OCAP REF.	RIF. ORIG O.E. NUMBER	NOTE REMARKS	MODELLO / DESCRIZIONE MODEL / DESCRIPTION
0506956   0186598 M=30x1,5 RHT	98469650 9844902	T=36 L=878	EUROCARGO - EUROCARGO TECTOR
0506971 	4668258		180NC/NT/NTS 691N/T/TS
0506976   0196603 M=25x1,5 LHT	4588688	L=707	645N1 650N1 662N1
0506977   0196603 M=25x1,5 LHT	4568702	L=705	650 E - 662 N
0506984 	4520744 4668402	L=865	690N1/N2/N3/N4
0506987   0186605 M=38x1,5 RHT	4545422	Lt=855	693N1/T1
0506991   0186603 M=25x1,5 RHT	8535664 8558651	L=630	OM: LUPETTO 2?



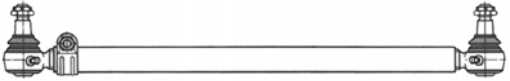

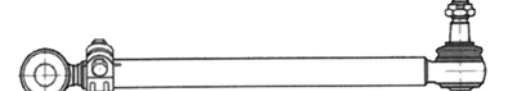
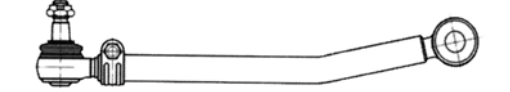







TIRANTI LONGITUDINALI - DRAG LINKS

RIF. OCAP OCAP REF.	RIF. ORIG O.E. NUMBER	NOTE REMARKS	MODELLO / DESCRIZIONE MODEL / DESCRIPTION
0506993   0186603 M=25x1,5 RHT	8525704	L=630	OM: TIGROTTO M3
0507153   0186604 M=28x1,5 RHT	8558653	Lt=775	OM 120
0507154   0186604 M=28x1,5 RHT	4546822 4573092	L=883	643N/N1
0507155   0186605 M=38x1,5 RHT	7136367	Lt=860	150N
0507161   0186599 M=38x1,5 RHT	4722108	L=975	220 F 38 TURBO
0507164   0186424 M=30x1,5 RHT	8573757	L=750	100.13/F13 2? d tilting cab)

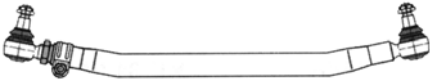

TIRANTI LONGITUDINALI - DRAG LINKS

RIF. OCAP OCAP REF.	RIF. ORIG O.E. NUMBER	NOTE REMARKS	MODELLO / DESCRIZIONE MODEL / DESCRIPTION
<p>0507171</p>  <p>0186603 M=25x1,5 RHT</p>	8533963	L=665	OM: DAINO TIGROTTO MA TIGROTTO 50-55Q.li
	41032826	T=48 L=1590	EUROTRAKKER 92-04
<p>0507287</p>  <p>0186598 M=30x1,5 RHT</p>	41016961 41005469 8135492 41011470 41017269	T=52 L=824	EUROSTAR STRALIS
<p>0507293</p>  <p>0186598 M=30x1,5 RHT</p>	41005475 4100609	T=52 L=952	EUROTRAKKER EUROTRAKKER CURSOR
<p>0507314</p>  <p>0186598 M=30x1,5 RHT</p>	42118694 4211553	T=60 L=1485	EUROTRAKKER EUROTRAKKER CURSOR TRAKKER
	5801282537 58012	T=52 L=953	EUROSTAR EUROTECH EUROTRAKKER TRAKKER STRALIS

TIRANTI LONGITUDINALI - DRAG LINKS

RIF. OCAP OCAP REF.	RIF. ORIG O.E. NUMBER	NOTE REMARKS	MODELLO / DESCRIZIONE MODEL / DESCRIPTION
0507368   0186598 M=30X1,5 RHT	504049893 580164	T=42 L=892	EUROCARGO TECTOR
0507369   0186598 M=30x1,5 RHT	500397738	T=36 L=959	EUROTECH EUROSTAR CURSOR TRAKKER STRALIS
0507370   0186598 M=30x1,5 RHT	41226580 4121516	T=52 L=959	EUROTRAKKER EUROTRAKKER CURSOR TRAKKER
0507850   0186598 M=30x1,5 RHT	98473328	T=50 L=966	EUROCARGO
0507851   0186598 M=30x1,5 RHT	98493054	T=40 L=887	EUROCARGO
0507852   0186424 M=30x1,5 RHT	500362533	L=1190	EUROCARGO TECTOR 130E24

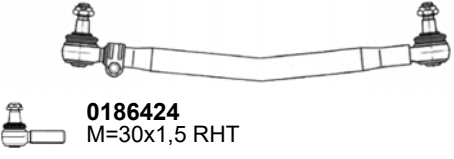
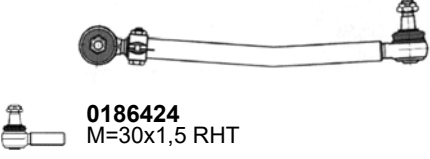
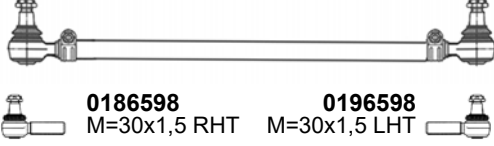
TIRANTI LONGITUDINALI - DRAG LINKS

RIF. OCAP OCAP REF.	RIF. ORIG O.E. NUMBER	NOTE REMARKS	MODELLO / DESCRIZIONE MODEL / DESCRIPTION
<p>0507853</p>  <p>0186424 M=30x1,5 RHT</p>	500363545	L=1114	EUROCARGO TECTOR 120E118
<p>0507859</p>  <p>0186424 M=30x1,5 RHT</p>	500324282	T=40 L=785	EUROCARGO
<p>0507866</p>  <p>0186598 0196598 M=30x1,5 RHT M=30x1,5 LHT</p>	504034521	T=42 L=1570	EUROCARGO I-III
<p>0507904</p>  <p>0186598 M=30x1,5 RHT</p>	41298449 4102826	T=52 L=887	EUROTRAKKER TRAKKER

TESTE STERZO - TIE RODS END

RIF. OCAP OCAP REF.	RIF. ORIG O.E. NUMBER	NOTE REMARKS	MODELLO / DESCRIZIONE MODEL / DESCRIPTION
0186424 	4833827 8122754 42493781 2966688 42495718 2966891 4833820	L=115 M=30x1,5 RHT	EUROCARGO - EUROCARGO TECTOR GAMMA ZETA
0196424 	4833828 2984511 4833821 8122755	L=115 M=30x1,5 LHT	EUROCARGO
0186598 	4833829 4833822 42483386 4802443 93163828 93190752	L=120 M=30x1,5 RHT	EUROTECH EUROSTAR EUROCARGO EUROTRAKKER STRALIS
0196598 	4833830 4833823 42489395 42489574 4802444	L=120 M=30x1,5 LHT	EUROCARGO EUROTECH EUROSTAR EUROTRAKKER STRALIS
0186599 	4688948	L=120 M=38x1,5 RHT	TURBOSTAR - TURBOTECH
0196599 	4688949	L=120 M=38x1,5 LHT	TURBOSTAR
0186603 	4018036 4663787	L=115 M=25x1,5 RHT	100.13/F13-100.14 110NC-100EC-100NC-314/3 OMN 100/10 LUPETTO-LEONCINO CERBIATTO-DAINO TIGROTTO
0186604 	4028250 4663972	L=117 M=28x1,5 RHT	110 NC var 837 TILT 643N/N1 673N-130NC 130NR-130NT



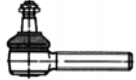
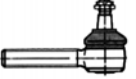
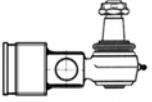
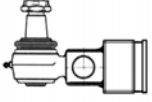
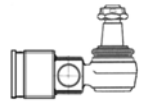
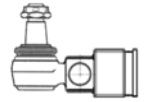
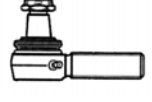
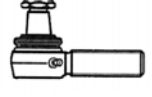

TESTE STERZO - TIE RODS END

RIF. OCAP OCAP REF.	RIF. ORIG O.E. NUMBER	NOTE REMARKS	MODELLO / DESCRIZIONE MODEL / DESCRIPTION
0196604 	4028251 4663974	L=117 M=28x1,5 LHT	110 NC var 837 TILT 643N/N1 673N-130NC 130NR-130N
0186605 	4664297 4510019 4664292 4510620	L=130 M=38x1,5 RHT	180NC/NT/NTS 682N2/N3/N4 682T2/T3/T4 683/619N 690N1/N2/N3/N4 691N/T/TS-693N/N1
0196605 	4523292 4664295	L=130 M=38x1,5 LHT	682N2/N3/N4 682T2/T3/T4-683N 619N-693N/N1
0186608 	4688941 8582332 7167757 8565366	L=115 M=28x1,5 RHT	GAMMA ZETA
0196608 	8582333	L=115 M=28x1,5 LHT	GAMMA ZETA
0186612 	93194626 8558527 42487165	L=105 M=24x1,5 RHT	OM
0196612 	8558524	L=105 M=24x1,5 LHT	OM
0186613 	42484886 4833825 8193645 8558533 8582322 2966321 2966635	L=105 M=28x1,5 RHT	GAMMA ZETA

TESTE STERZO - TIE RODS END

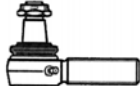
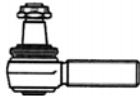
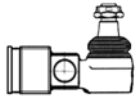
RIF. OCAP OCAP REF.	RIF. ORIG O.E. NUMBER	NOTE REMARKS	MODELLO / DESCRIZIONE MODEL / DESCRIPTION
0196613 	42484887 4833826 8123394 8193646 8558536 2969507	L=105 M=28x1,5 LHT	GAMMA ZETA
0186614 	9009501 4579231	L=98 M=18x1,5 RHT	NC
0196614 	9009503 4579232	L=98 M=18x1,5 LHT	OM
0186648 	4665007	L=120 M=64x1,5 RHT	100 F13/-NC-110NC-130NC/NR/NT 645N/N1-650E-650N/N1/N2/N3 655N/N1-662N/N2/N3-673N Servosterzo (Power steering)
0186649 	4665005	L=120 M=64x1,5 RHT	100 F13/-NC-110NC-130NC/NR/NT 645N/N1-650E-650N/N1/N2/N3 655N/N1-662N/N2/N3-673N Servosterzo (Power steering)
0186655 	4688952	LHD M=64x1,5 RHT	170NC26/NC33/NC35 170NT26/NT33/NT35 190NC26/NC 33/NC35 190NT26/NT33/NT 35 Servosterzo (Power steering axle)
0186656 	4688951	RHD M=64x1,5 RHT	170NC26/NC33/NC35 170NT26/NT33/NT35 190NC26/NC 33/NC35 190NT26/NT33/NT35 Servosterzo (Power steering axle)
0186657 	4520697 4664586	L=130 M=38x1,5 RHT	180NC-180NT-180NTS 690N1/N2/N3/N4-691N1/TS
0186684 	4580778	L=130 M=38x1,5 RHT	682N2/N3/N4 682T2/T3/T4 Servosterzo (Power steering)

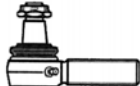
TESTE STERZO - TIE RODS END

RIF. OCAP OCAP REF.	RIF. ORIG O.E. NUMBER	NOTE REMARKS	MODELLO / DESCRIZIONE MODEL / DESCRIPTION
0186758 	42537936 8122752 4833829 042489573	L=135 M=30x1,5 RHT	EUROCARGO TURBOTECH EUROTRAKKER
0187152 	4580782	L=130 M=38x1,5 RHT	682N2/N3/N4 682T2/T3/T4 Servosterzo (Power steering)
0187158 	61595957 *	L=105 M=25x1,5 RHT	100 NC
0187160 	4688944	M=64x1,5 RHT	60.10/.F10 - 60.11 T. ZETA 65.9/.12-65.10/.F10 T.ZETA 79.10/.F10/.12 T.ZETA 90.13/.F13 100.13/.F13-109.14 ZETA 115.14 - 115.17-135.14/.14H 135.17 e deriv.-145.17 - 150.14/.17 150.NC17/NC20/NR20/NT20 Servosterzo (Power steering axle)
0188994 	42538384	L=140 M=30x1,5 RHT	EUROCARGO I-II-III EUROTRAKKER TURBOTECH
0196603 	4018037	L=115 M=25x1,5 LHT	GAMMA ZETA
0280515 	1903652 93804059 93800662	L=80 M=16x1,5 RHT	DAILY I-II
0286606 	4510017 4664349	L=175 M=45x1,5 RHT	180NC/NT/NTS 682N2/N3/N4 682T2/T3/T4 690N1/N2/N3/N4 691N/TS

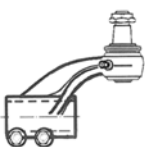
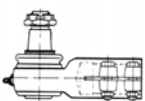
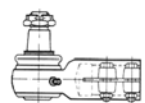
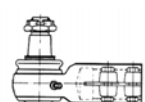
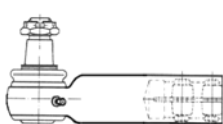
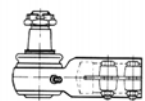
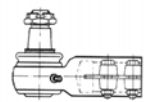

TESTE STERZO - TIE RODS END

RIF. OCAP OCAP REF.	RIF. ORIG O.E. NUMBER	NOTE REMARKS	MODELLO / DESCRIZIONE MODEL / DESCRIPTION
0296606 	4510018 4664347	L=175 M=45x1,5 LHT	180NC/NT/NTS 682N2/N3/N4 682T2/T3/T4 690N1/N2/N3/N4 691N/TS
0286610 	4664353 4732041 4514235	L=190 M=52x1,5 RHT	160NC/NT/R 300PC/PT 619NI/NIP/TI/TIP 684N/NP/T/TP 697N/NP/T/TP
0286647 	4665009	L=130 M=30x1,5 RHT	100 F13/-NC-110NC-130NC/NR/NT 645N/N1-650E-650N/N1/N2/N3 655N/N1-662N/N2/N3-673N Servosterzo (Power steering)
0286650 	4514245 466446	L=138 M=30x1,5 RHT	160NC/NT-300PC 684AN/NP/T/TP-690N1/N2/N3/N4 619N1/N1P-697N/NP TESTA ANT.LHD TIEROD END FRONT LHD Servosterzo (Power steering)
0286652 	4582159 4664462	L=138 M=30x1,5 RHT	160NC/NT/-300PC/PT 619N1/N1P-697NP-684N/NP/T/TP Servosterzo (Power steering)
0286658 	4665422 4668206	L=200 M=30x1,5 RHT	180NC/NT/NTS 691N/T-691TS Servosterzo (Power Steering)
0286665 	4025438	L=138 M=30x1,5 RHT	682N2/N3/N4 682T2/T3/T4 Servosterzo (Power Steering)
0287150 	4664090	L=130 M=30x1,5 RHT	643N/N1 Servosterzo (Power Steering)





TESTE STERZO - TIE RODS END

RIF. OCAP OCAP REF.	RIF. ORIG O.E. NUMBER	NOTE REMARKS	MODELLO / DESCRIZIONE MODEL / DESCRIPTION
0287238 	55175540	L=91 M=30x1,5 RHT	EUROTECH EUROSTAR
0287320 	42530316 4253804	L=86 M=30x1,5 RHT	EUROTRAKKER TRAKKER
0287360 	42533101	L=90 M=26x1,5 RHT	EUROTECH EUROSTAR STRALIS
0287361 	42533073	L=75 M=26x1,5 RHT	EUROTECH EUROSTAR STRALIS
0287552 	42534911 93827647 42556991	L=80 M=16x1,5 RHT	DAILY III-IV-V
0287906 	42533102	L=80 M=26x1,5 RHT	EUROTECH EUROSTAR STRALIS TRAKKER
0288003 	-	L=79 M=26x1,5 RHT	
0289425 	42569563	L=109 M=16x1,5 RHT	DAILY VI
0289426 	42569562	L=87 M=16x1,5 RHT	DAILY VI



TESTE STERZO - TIE RODS END

RIF. OCAP OCAP REF.	RIF. ORIG O.E. NUMBER	NOTE REMARKS	MODELLO / DESCRIZIONE MODEL / DESCRIPTION
0289476 	500053864	L=80 M=18x1,5RHT	DAILY SUD AMERICA
0289923 	42538048 4253044	L=90 M=36X1,5 RHT	TRAKKER





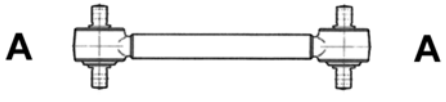
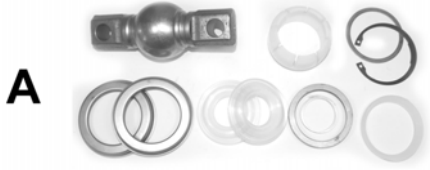

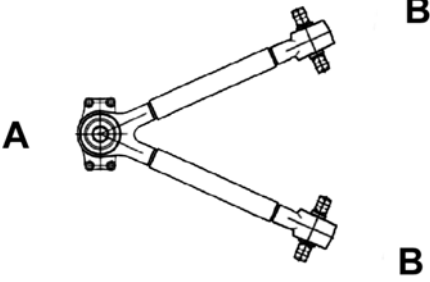
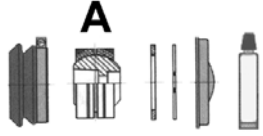
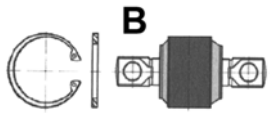
SNODI ASSIALI - AXIAL JOINTS

RIF. OCAP OCAP REF.	RIF. ORIG O.E. NUMBER	NOTE REMARKS	MODELLO / DESCRIZIONE MODEL / DESCRIPTION
0600516 	9983325	L=310 M=16x1,5 RHT	DAILY I - II
0602749 	2992593	L=367 M=16x1,5 RHT	DAILY III - IV - V
0606927 	7820249212	 M=16x1,5 RHT	DAILY I - II
0607552 	42532977 9946326	L=348 M=16x1,5 RHT	DAILY III - IV
0609422 	42569566	L=348 M=18x1,5 RHT	DAILY VI



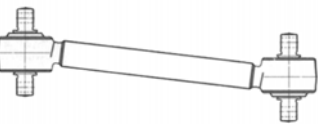
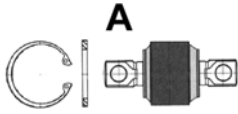

BARRE DI REAZIONE - TORQUE RODS

RIF. OCAP OCAP REF.	RIF. ORIG O.E. NUMBER	NOTE REMARKS	MODELLO / DESCRIZIONE MODEL / DESCRIPTION
0807207 	4714134	L=583 d=19	TURBOSTAR TURBOTECH
0907258 	2980884	p=30 l=130 D=65 d=19	
0907757 	-	D=65	
0807211 	41042050 41034479 41028598 41002770 41009665 225.027 (4)	T=46 L=665 d=21	EUROTECH EUROSTAR EUROTRAKKER STRALIS TRAKKER
0907297 	93161958 9316163	D=65 lK=38	
0907296 	93161960	p=24 l=130 D=62 d=21	





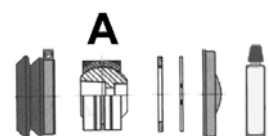

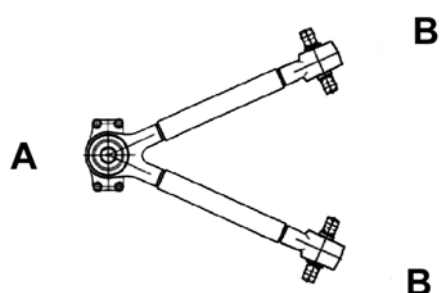
BARRE DI REAZIONE - TORQUE RODS

RIF. OCAP OCAP REF.	RIF. ORIG O.E. NUMBER	NOTE REMARKS	MODELLO / DESCRIZIONE MODEL / DESCRIPTION
<p>0807225</p>  <p>A A</p>	41009961	T=50 L=455	EUROSTAR EUROTECH STRALIS
<p>0907327</p>  <p>A</p>	93192361	p=24 l=130 D1=75 d=19	
<p>0807226</p>  <p>A A</p>	41033731	T=50 L=455	EUROSTAR EUROTECH STRALIS
<p>0907327</p>  <p>A</p>	93192361	p=24 l=130 D1=75 d=19	
<p>0807262</p>  <p>A A</p>	42034054 4200048	L=610 d=21	330.26 330.30 Turbo 330.35-330.36 TURBOTECH
<p>0907262</p>  <p>A</p>	2983125	p=35 l=152 D=80 d=21	
<p>0807292</p>  <p>A A</p>	500340452 410032	T=52 L=594 d=19,5	EUROSTAR EUROTECH STRALIS
<p>0907327</p>  <p>A</p>	93192361	p=24 l=130 D1=75 d=19	

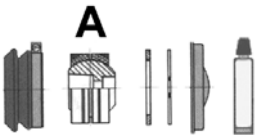
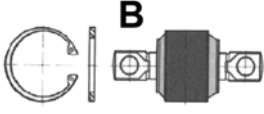



BARRE DI REAZIONE - TORQUE RODS

RIF. OCAP OCAP REF.	RIF. ORIG O.E. NUMBER	NOTE REMARKS	MODELLO / DESCRIZIONE MODEL / DESCRIPTION
<p>0807295</p> 	<p>42065332 41011006 5801304684</p>	<p>T=58 L=610 d=21</p>	<p>EUROTRAKKER EUROTRAKKER CURSOR TRAKKER</p>
<p>0907330</p> 	<p>93192619 4249343</p>	<p>p=24 l=152 D=80 d=21</p>	
<p>0807296</p> 	<p>504064007 41042092 98472468 41028599</p>	<p>L=665 d=21</p>	<p>EUROCARGO EUROCARGO TECTOR EUROTECH</p>
<p>0907297</p> 	<p>93161958 9316163</p>	<p>D=65 IK=38</p>	
<p>0907327</p> 	<p>93192361</p>	<p>p=24 l=130 D1=75 d=19</p>	
<p>0807299</p> 	<p>41042093 5003404</p>	<p>L=665 d=21</p>	<p>STRALIS</p>





BARRE DI REAZIONE - TORQUE RODS

RIF. OCAP OCAP REF.	RIF. ORIG O.E. NUMBER	NOTE REMARKS	MODELLO / DESCRIZIONE MODEL / DESCRIPTION
<p>0907299</p> 	<p>93161631 9316163</p>	<p>L=46 IK=38 D=65</p>	
<p>0907296</p> 	<p>93161960</p>	<p>p=24 l=130 D=62 d=21</p>	
<p>0807336</p> 	<p>98472871</p>	<p>L=594 d=19</p>	EUROTECH
<p>0907327</p> 	<p>93192361</p>	<p>p=24 l=130 D1=75 d=19</p>	
<p>0807358</p> 	<p>41035951 98472466 41009661 41272429 8137027</p>	<p>L=590 d=19</p>	EUROCARGO TECTOR EUROTECH EUROSTAR EUROTRAKKER STRALIS TRAKKER
<p>0907327</p> 	<p>93192361</p>	<p>p=24 l=130 D1=75 d=19</p>	
<p>0807363</p> 	<p>41218021 5801384823 01902137</p>	<p>T=60 L=582</p>	TRAKKER
<p>0907330</p> 	<p>93192619 4249343</p>	<p>p=24 l=152 D=80 d=21</p>	







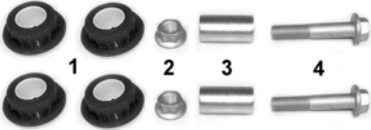

BARRE DI REAZIONE - TORQUE RODS

RIF. OCAP OCAP REF.	RIF. ORIG O.E. NUMBER	NOTE REMARKS	MODELLO / DESCRIZIONE MODEL / DESCRIPTION
0807372 	41218621 4121862	T=48 L=665 I=152/130 d=25/21	TRAKKER STRALIS
0807373 	41272706 412727	T=48 L=665 I=152 d=25	STRALIS TRAKKER
0907774 	41272706 0003502405 81432706110	p=24 I=152 D1=100 d=25	
0807374 	41296730 4129673	T=48 L=665 I=152 d=25	STRALIS TRAKKER
0907774 	41272706 0003502405 81432706110	p=24 I=152 D1=100 d=25	

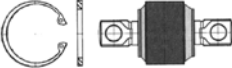

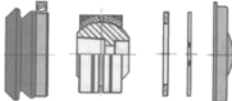



BARRE DI REAZIONE - TORQUE RODS

RIF. OCAP OCAP REF.	RIF. ORIG O.E. NUMBER	NOTE REMARKS	MODELLO / DESCRIZIONE MODEL / DESCRIPTION
<p>0807579</p> 	<p>42041107 41011</p>	<p>T=50 L=610 I=152 d=21</p>	<p>EUROTECH EUROSTAR EUROTRAKKER STRALIS TRAKKER</p>
<p>0907304</p> 	<p>93192618 93161720 42535046</p>	<p>p=24 I=152 D1=85 d=21</p>	
<p>0809418</p> 	<p>93163964 9945857</p>	<p>T=28,7 L=635</p>	<p>EUROCARGO</p>
<p>0809448</p> 	<p>41272428</p>	<p>T=48 L=665 I=152/130 d=25/21</p>	<p>TRAKKER</p>
<p>0907774</p> 	<p>41272706 0003502405 81432706110</p>	<p>p=24 I=152 D1=100 d=25</p>	

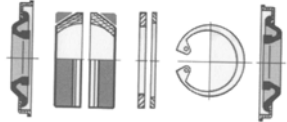

KIT DI SOSPENSIONE - SUSPENSION KITS

RIF. OCAP OCAP REF.	RIF. ORIG O.E. NUMBER	NOTE REMARKS	MODELLO / DESCRIZIONE MODEL / DESCRIPTION
0903144 	504039506 *		DAILY III - IV - V ASSE ANTERIORE - FRONT AXLE
0907258 	2980884	p=30 l=130 D=65 d=19	STRALIS TURBOSTAR TURBOTECH
0907262 	2983125	p=35 l=152 D=80 d=21	
0907296 	93161960	p=24 l=130 D=62 d=21	EUROCARGO - EUROCARGO TECTOR EUROTECH EUROSTAR EUROTRAKKER STRALIS TRAKKER
0907297 	93161958 9316163	D=65 lK=38	EUROCARGO EUROTECH EUROSTAR EUROTRAKKER STRALIS TRAKKER
0907304 	93192618 93161720 42535046	p=24 l=152 D1=85 d=21	EUROSTAR EUROTECH EUROTRAKKER TRAKKER STRALIS
0907327 	93192361	p=24 l=130 D1=75 d=19	EUROCARGO TECTOR EUROTECH EUROSTAR EUROTRAKKER STRALIS TRAKKER
0907330 	93192619 4249343	p=24 l=152 D=80 d=21	EUROTRAKKER EUROTRAKKER CURSOR TRAKKER







KIT DI SOSPENSIONE - SUSPENSION KITS

RIF. OCAP OCAP REF.	RIF. ORIG O.E. NUMBER	NOTE REMARKS	MODELLO / DESCRIZIONE MODEL / DESCRIPTION
0907578 	93161371	I=130 D=65 d=19	TURBOSTAR TURBOTECH
0907586 	5861533 09316137	D=65	TURBOSTAR TURBOTECH
0907757 	-	D=65	TURBOSTAR TURBOTECH
0907774 	41272706 0003502405 81432706110	p=24 I=152 D1=100 d=25	STRALIS - TRAKKER
0907927 	93163617	p=24 D=67 d=19	EUROCARGO EUROTECH
0909422 	5801564281 5801564274 5801564276	L=25,2 D=17 mm.	DAILY VI ASSE ANTERIORE - FRONT AXLE
1215269 	93807641	D=32 mm.	DAILY II - III
1215270 	93807640	D=29 mm.	DAILY I-II-III-IV-V-VI



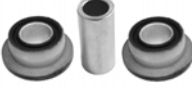



KIT DI SOSPENSIONE - SUSPENSION KITS

RIF. OCAP OCAP REF.	RIF. ORIG O.E. NUMBER	NOTE REMARKS	MODELLO / DESCRIZIONE MODEL / DESCRIPTION
1215271 	93810239	D=37 mm.	DAILY I-II-III-IV-V
1215953 	504039506		DAILY III - IV - V ASSE ANTERIORE - FRONT AXLE

BRACCI OSCILLANTI - TRACK CONTROL ARMS

RIF. OCAP OCAP REF.	RIF. ORIG O.E. NUMBER	NOTE REMARKS	MODELLO / DESCRIZIONE MODEL / DESCRIPTION
0709422  A B	5801564293		DAILY VI ANTERIORE - SUPERIORE FRONT - UPPER
0409422  A	5801564293 *		
0909422  B	5801564281 5801564274 5801564276	L=25,2 D=17 mm.	
0709423  A B	5801564316		DAILY VI ANTERIORE - INFERIORE FRONT - LOWER
0409423  A	5801564316 *		
0909422  B	5801564281 5801564274 5801564276	L=25,2 D=17 mm.	
0787249  A B	500379802 42551297 500344888		DAILY III - IV - V ANTERIORE - SUPERIORE FRONT - UPPER



BRACCI OSCILLANTI - TRACK CONTROL ARMS

RIF. OCAP OCAP REF.	RIF. ORIG O.E. NUMBER	NOTE REMARKS	MODELLO / DESCRIZIONE MODEL / DESCRIPTION
0797249  B A	500379801 42551296 500344887 500379802		DAILY III - IV - V ANTERIORE - SUPERIORE FRONT - UPPER
0407249  A	500379801 500334713 500344888 500379802 500334714 500344887	m=16x1,5 RHT D=43,95 mm.	
1215953  B	504039506		
0787250  A B	500334716 500334486 42551289		DAILY III - IV - V ASSE ANTERIORE - INFERIORE FRONT AXLE - LOWER
0797250  B A	500334717 500334487 42551290 500334716		DAILY III - IV - V ASSE ANTERIORE - INFERIORE FRONT AXLE - LOWER
0407250  A	500334716 500334	m=18x1,5 RHT D=44,95 mm.	
1215953  B	504039506		

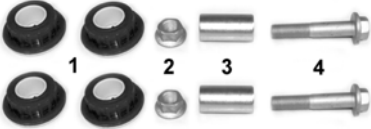

BRACCI OSCILLANTI - TRACK CONTROL ARMS

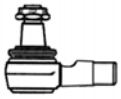
RIF. OCAP OCAP REF.	RIF. ORIG O.E. NUMBER	NOTE REMARKS	MODELLO / DESCRIZIONE MODEL / DESCRIPTION
<p>0903144</p> 	<p>504039506 *</p>		<p>DAILY III - IV - V ASSE ANTERIORE - FRONT AXLE</p>



SNODI SOSPENSIONI - SUSPENSION JOINTS

RIF. OCAP OCAP REF.	RIF. ORIG O.E. NUMBER	NOTE REMARKS	MODELLO / DESCRIZIONE MODEL / DESCRIPTION
0187156 	2463583	M=20x1,5	330.35
0187157 	2460515	L=95	330.26/.30/.35H 330.30/.35HT
0280517 	93802209 93804060 500310933	L=72 m=18x1,5 RHT M=20x1,5 RHT	DAILY I-II-III-IV-V-VI
0286616 	500337201 858073	L=80 m=18x1,5 RHT M=20x1,5 RHT	DAILY II - III
0400518 	93802242 93807545 93807320	m=18x1,5 RHT M=20x1,5 RHT	DAILY III - IV - V - VI
0407249 	500379801 500334713 500344888 500379802 500334714 500344887	m=16x1,5 RHT D=43,95 mm.	DAILY III - IV - V ANTERIORE - SUPERIORE FRONT - UPPER
0407250 	500334716 500334	m=18x1,5 RHT D=44,95 mm.	DAILY III - IV - V ASSE ANTERIORE - INFERIORE FRONT AXLE - LOWER
0407893 	504212586 504212	m=18x1,5 RHT M=20x1 RHT	DAILY III-IV-V-VI



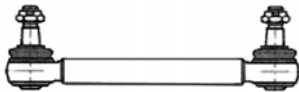

SNODI SOSPENSIONI - SUSPENSION JOINTS

RIF. OCAP OCAP REF.	RIF. ORIG O.E. NUMBER	NOTE REMARKS	MODELLO / DESCRIZIONE MODEL / DESCRIPTION
0407894 	5801378064	m=18x1,5 RHT M=20x1,5 RHT	DAILY III MOD. 90 Q.li
0409422 	5801564293 *		DAILY VI SNODO SOSPENSIONE ASSE ANTERIORE - SUPERIORE BALL JOINT FRONT AXLE - UPER
0409423 	5801564316 *		DAILY VI SNODO SOSPENSIONE ASSE ANTERIORE - INFERIORE BALL JOINT FRONT AXLE - LOWER

STABILIZZATORI - STABILIZERS

RIF. OCAP OCAP REF.	RIF. ORIG O.E. NUMBER	NOTE REMARKS	MODELLO / DESCRIZIONE MODEL / DESCRIPTION
0507165 	4741171	L=355	TURBOSTAR
0587871 	500383975		DAILY III ASSE ANTERIORE - FRONT AXLE
0597871 	500383976		DAILY III ASSE ANTERIORE - FRONT AXLE

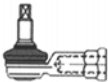
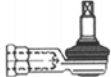
TESTE COMANDO CAMBIO - GEAR BOX CONTROL BALL JOINTS

RIF. OCAP OCAP REF.	RIF. ORIG O.E. NUMBER	NOTE REMARKS	MODELLO / DESCRIZIONE MODEL / DESCRIPTION
0181785 	42042912 4121848	L=90 M=16x1,5 RHT	EUROSTAR EUROTECH EUROCARGO I-III EUROTRAKKER STRALIS
0187228 	7981909	L=85 M=14x1,5 RHT	TURBOSTAR TURBOTECH
0186949 	41005523	L=75 M=16x1,5 RHT	EUROTRAKKER EUROTECH: 190E34/38
0281786 	41203863	L=55 M=10x1,5 RHT	EUROSTAR EUROTECH EUROTRAKKER
0291786 	42041328 41002119 42079850 42079852 41203864	L=55 M=10x1,5 LHT	EUROSTAR EUROTECH EUROTRAKKER
0187226 	8578493 8582313	L=85 M=14x1,5 RHT	50.9-60.11- 65.9/.12 79.12-79.14 Posteriore - Rear
0187234 	8578492	L=90 M=16x1,5 RHT	50.9-60.11-65.9/.12 79.12-79.14 anteriore-front



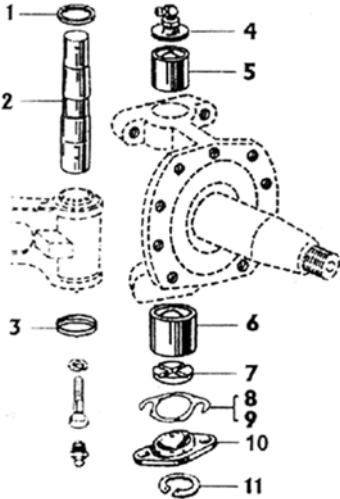
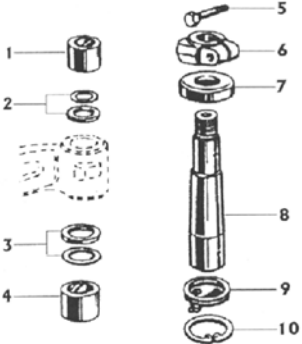
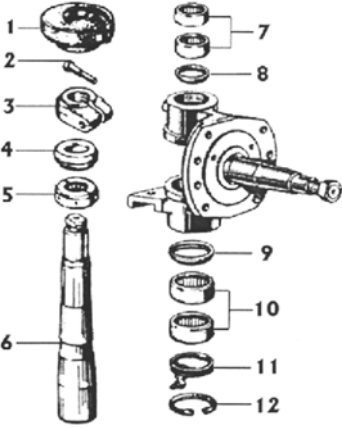

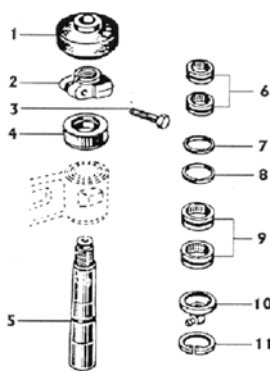
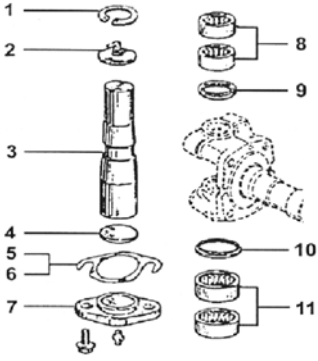

KIT PERNO FUSO - KING PIN SET

RIF. OCAP OCAP REF.	RIF. ORIG O.E. NUMBER	NOTE REMARKS	MODELLO / DESCRIZIONE MODEL / DESCRIPTION
0927365 	- 7162998 7162882 7162624 7162462 4676170 4676168 7163000 (1) 7162998 (2) 7162882 (3) 7164257 (4) 7162624 (5) 7162462 (6) 4676168 (7) 7173083 (8) 7173081 (9) 4676170 (10) 11059375 (11)	L=173 D=27/34	(KIT COMPLETO PER Nr. 2 RUOTE) (KIT SUITABLE FOR Nr. 2 WHEELS) 50/55.8/F8.9/F9.10/F10 60.8/F8 - 60/65/70.10/F10 75/79.10/F10 - 79/80/90.13/F13 60.11 TURBO Z 50/65.9Z - 65.12 TURBO Z
0927383 	- 4613620 4608393 4596824 4596822 4596193 7160200 (1) 4596822 (2) 4596824 (3) 4608393 (4) 15540921 (5) 4540023 (6) 4613620 (7) 4596193 (8) 7164263 (9) 11060976 (10)	L=266,5 D=41,2/50,8	(KIT COMPLETO PER Nr. 2 RUOTE) (KIT SUITABLE FOR Nr. 2 WHEELS) 693N1 U.T. 619N1/N1P 697N/NP 300PC/PT
0927387 	- 4691212 15540921 4540023 7162586 4691212 (1) 15540921 (2) 4540023 (3) 7162586 (4) 4691211 (5) 7161882 (6) 7161012 (7) 7162447 (8) 7162448 (9) 716013 (10) 7164263 (11) 11060976 (12)	L=277,5 D=41,2/50,8	(KIT COMPLETO PER Nr. 2 RUOTE) (KIT SUITABLE FOR Nr. 2 WHEELS) 180.24/.24T/.26 190i26/i26T/i35/i35T 190.30/.30P/.30T/.30PT/.38/.38P/.38T/.38PT 190.33/.36/.42/.48 TURBOSTAR 220.38T/.38PT - 220F35T - 220.36PT 240.30/.30P - 240.38/.38P - 240.36P 159/175.17 - 165/175.24R/.24T

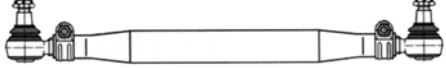
KIT PERNO FUSO - KING PIN SET

RIF. OCAP OCAP REF.	RIF. ORIG O.E. NUMBER	NOTE REMARKS	MODELLO / DESCRIZIONE MODEL / DESCRIPTION
<p>0927388</p> 	<p>-</p> <p>7162448 15540921 7161012 7162447 4691212 (1) 4540023 (2) 15540921 (3) 7162586 (4) 7161882 (5) 7161012 (6) 7162447 (7) 7162448 (8) 716013 (9) 7164263 (10) 11060976 (11)</p>	<p>L=277,5</p> <p>D=41,2/50,8</p>	<p>(KIT COMPLETO PER Nr. 2 RUOTE) (KIT SUITABLE FOR Nr. 2 WHEELS)</p> <p>330.26H/.26HT/.26N 330.30H/.30HT 330.35H/.35HT</p>
<p>0927391</p> 	<p>-</p> <p>7173052 7173077 7173083 7173081 11060076 (1) 7173052 (2) 7173087 (3) 7173077 (4) 7173083 (5) 7173081 (6) 7173086 (7) 7173061 (8) 40101041 (9) 40101051 (10) 7172870 (11)</p>	<p>L=178</p> <p>D=28/35</p>	<p>(KIT COMPLETO PER Nr. 2 RUOTE) (KIT SUITABLE FOR Nr. 2 WHEELS)</p> <p>EUROCARGO: 60/65E10/E12/E14 75E12/E14/E15 95E18 80/100E15/E18/E21 180E21</p>

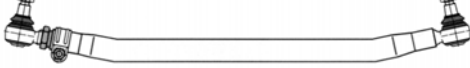



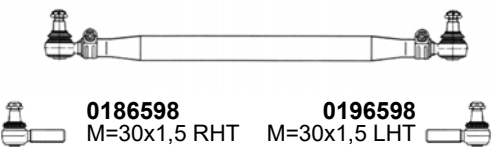
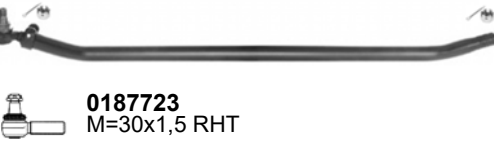
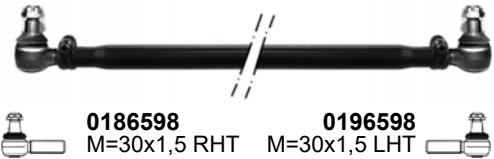

BARRE ACCOPPIAMENTO - TIE RODS

RIF. OCAP OCAP REF.	RIF. ORIG O.E. NUMBER	NOTE REMARKS	MODELLO / DESCRIZIONE MODEL / DESCRIPTION
<p>0507807</p>  <p>0186598 M=30x1,5 RHT 0196598 M=30x1,5 LHT</p>	<p>81467106353 81467116820 81467116725 81467106361 81467106354 81467106112 81467106163 81467106165 81467106198</p>	<p>T=50 L=1652</p>	<p>M2000 TGA - TGS - TGX</p>
<p>0507814</p>  <p>0186613 M=28x1,5 RHT 0196613 M=28x1,5 LHT</p>	<p>81467116894 81467116803 81467116805 81467116893 81467116896</p>	<p>T=36 L=1632</p>	<p>L2000 M2000 TGL - TGM</p>
<p>0507817</p>  <p>0186598 M=30x1,5 RHT</p>	<p>81467116736 81467106830 81467106167</p>	<p>T=52 L=1588</p>	<p>M2000 TGA - TGS</p>
<p>0507841</p>  <p>0186595 M=24x1,5 RHT 0196595 M=24x1,5 LHT</p>	<p>81467106866 81467106865 81467116717 81467116728</p>	<p>T=30 L=1645</p>	<p>L2000</p>
<p>0507843</p>  <p>0187843 M=30x1,5</p>	<p>81467116711 81467106932 81467106933 81467106934 81467106785 81467106846</p>	<p>T=50 L=1650</p>	<p>M2000</p>
<p>0507846</p>  <p>0186598 M=30x1,5 RHT</p>	<p>81467106442 81467106443 81467106460</p>	<p>L=1005</p>	<p>M 90: 17.192-17.232-17.272-18.192 18.222-18.232-18.262-18.272 24.192-24.222-24.232-24.262 24.272</p>







BARRE ACCOPPIAMENTO - TIE RODS

RIF. OCAP OCAP REF.	RIF. ORIG O.E. NUMBER	NOTE REMARKS	MODELLO / DESCRIZIONE MODEL / DESCRIPTION
<p>0507848</p>  <p>0186598 M=30x1,5 RHT 0196598 M=30x1,5 LHT</p>	<p>81466106579 81466106580 81466106583 81466106624 81466106640 81467116720</p>	<p>T=50 L=1530</p>	<p>F2000 - TGA-TGS-TGX</p>
<p>0507915</p>  <p>0187723 M=30x1,5 RHT</p>	<p>81467116773 81467116859 81467116921 81467116860 81467116861 81467116863</p>	<p>T=50 L=1679</p>	<p>M2000 TGA - TGS - TGX</p>
<p>0509417</p>  <p>0186598 M=30x1,5 RHT 0196598 M=30x1,5 LHT</p>	<p>81467116933 8146</p>	<p>T=42 L=1680</p>	<p>TGA - TGS - TGX</p>







TIRANTI LONGITUDINALI - DRAG LINKS

RIF. OCAP OCAP REF.	RIF. ORIG O.E. NUMBER	NOTE REMARKS	MODELLO / DESCRIZIONE MODEL / DESCRIPTION
<p>0506443</p>  <p>0186442 M=30x1,5 RHT</p>	81466106721	T=48 L=1040	F2000
<p>0506444</p>  <p>0186598 M=30x1,5 RHT</p>	81466106280	L=815	16.280-19.240-19.280 20.281-22.280-26.280 32.280
<p>0506445</p>  <p>0186598 M=30X1,5 RHT</p>	81466106288 8146	L=800	423-532
<p>0506446</p>  <p>0186595 M=24x1,5 RHT</p>	85466106102	T=32 L=826	L 2000
<p>0507215</p>  <p>0186424 M=30x1,5 RHT</p>	85466106019 85466106119 85466106150 85466106219	T=40 L=910	M 2000
<p>0507408</p>  <p>0186598 M=30x1,5 RHT</p>	81466116199 81466116200 81466116206 81466116104 81466116105 81466116134 81466116135 81466116137	T=52 L=967	TGA - TGS - TGX







TIRANTI LONGITUDINALI - DRAG LINKS

RIF. OCAP OCAP REF.	RIF. ORIG O.E. NUMBER	NOTE REMARKS	MODELLO / DESCRIZIONE MODEL / DESCRIPTION
<p>0507409</p>  <p>0186598 M=30x1,5 RHT</p>	<p>81466116004 81466116003 81466116005</p>	<p>T=42 L=1063</p>	<p>F 2000</p>
<p>0507533</p>  <p>0186613 M=28x1,5 RHT</p>	<p>85466106140 85466106021 85466106121 85466106221</p>	<p>T=38 L=840</p>	<p>L2000 M2000 TGL</p>
<p>0507812</p>  <p>0186613 M=28x1,5 RHT</p>	<p>85466106246 8546</p>	<p>T=38 L=864</p>	<p>TGL</p>
<p>0507815</p>  <p>0186424 M=30x1,5 RHT</p>	<p>81466106692 81466106693 81466106695 85466106020 85466106151</p>	<p>T=42 L=960</p>	<p>M 2000</p>
<p>0507820</p> 	<p>81466106790 81466106791 82466106191</p>	<p>T=52 L=1749</p>	<p>F 2000</p>
<p>0507822</p>  <p>0186442 M=30x1,5 RHT</p>	<p>81466106779 81466106780 81466106782</p>	<p>T=48 L=1060</p>	<p>F 2000</p>





TIRANTI LONGITUDINALI - DRAG LINKS

RIF. OCAP OCAP REF.	RIF. ORIG O.E. NUMBER	NOTE REMARKS	MODELLO / DESCRIZIONE MODEL / DESCRIPTION
<p>0507839</p>  <p>0186613 M=28x1,5 RHT</p>	<p>81466106754 85466106104 81466106753 85466106031 85466106203 85466106006</p>	<p>T=38 L=825</p>	<p>L2000</p>
<p>0507917</p>  <p>0186758 M30x1,5 RHT</p>	<p>81466116096 81466116097 81466116198 81466116205 81466116197 81466116133 81466116132 81466116087</p>	<p>T=52 L=993</p>	<p>TGA - TGS - TGX</p>
<p>0507955</p>  <p>0186598 0196598 M30x1,5 RHT M30x1,5 LHT</p>	<p>81466106374 81466116019 82466106080 82466106189 82466106190</p>	<p>T=42 L=1050</p>	<p>F 2000</p>
<p>0509415</p>  <p>0186598 M=30x1,5 RHT</p>	<p>81466106813 81466116204 81466116146 81466116147 81466116148</p>	<p>T=50 L=960</p>	<p>TGA - TGS</p>
<p>0509968</p>  <p>0186613 M=28x1,5 RHT</p>	<p>85466106162</p>	<p>T=38 L=820</p>	<p>TGL</p>
<p>0509982</p> 	<p>81466116161 81466116152 81466116162 81466116163 81466116142</p>	<p>T=62 L=1800</p>	<p>TGA - TGS</p>







TESTE STERZO - TIE RODS END

RIF. OCAP OCAP REF.	RIF. ORIG O.E. NUMBER	NOTE REMARKS	MODELLO / DESCRIZIONE MODEL / DESCRIPTION
0186442 	81953016263	L=155 M=30x1,5 RHT	E2000 F2000
0186595 	81953016142 81953016303 81953016321 81953010077 81953016134	L=95 M=24X1,5 RHT	L2000 M2000
0196595 	81953016141 81953016322 81953016304 81953010078	L=95 M=24X1,5 LHT	L2000 M2000
0186613 	81953016328 81953016358 81953016249 81953016060 81953016135 81953016140	L=105 M=28x1,5 RHT	L2000 M2000 TGL
0196613 	81953010079 81953016222 81953016139	L=105 M=28x1,5 LHT	L2000 M2000 TGL - TGM
0186758 	81953010022	L=135 M=30x1,5 RHT	TGA - TGS - TGX
0187723 	81953016288 8195	L=150 M=30x1,5 RHT	L2000 M2000 TGA - TGM - TGS - TGX
0187843 	81953016270	L=141 M=30x1,5 RHT	L2000 M2000

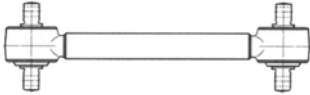

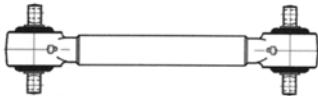

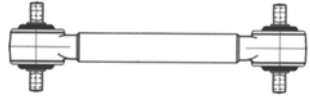

TESTE STERZO - TIE RODS END

RIF. OCAP OCAP REF.	RIF. ORIG O.E. NUMBER	NOTE REMARKS	MODELLO / DESCRIZIONE MODEL / DESCRIPTION
0188994 	81953016286	L=140 M=30x1,5 RHT	TGA - TGS - TGX
0287360 	82953016016 81953016337 81953016281	L=90 M=26x1,5 RHT	TGA - TGS - TGX
0287361 	81953016280	L=75 M=26x1,5 RHT	TGA - TGS - TGX
0289923 	81953016268 81953016018 81953016019	L=90 M=36X1,5 RHT	TGA - TGS

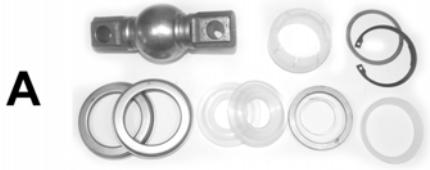

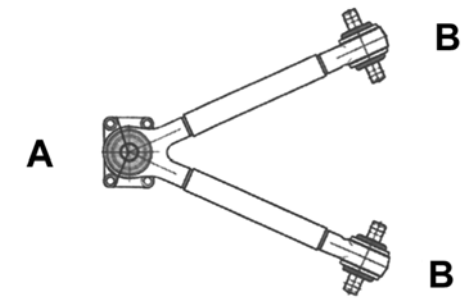

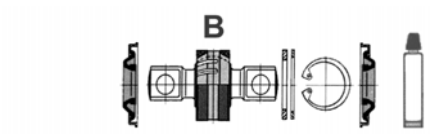

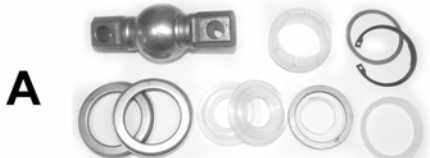

BARRE DI REAZIONE - TORQUE RODS

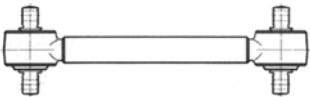
RIF. OCAP OCAP REF.	RIF. ORIG O.E. NUMBER	NOTE REMARKS	MODELLO / DESCRIZIONE MODEL / DESCRIPTION
<p>0807214</p> <p>A  A</p> <p>0907405</p> 	<p>81432206052 81432206010 81432206012 81432206013 81432206020 81432206035 81432206040 81432206041 81432206056 81432306018 81432306028</p> <p>81432206202</p>	<p>L=565</p> <p>d=19</p> <p>I=100 D=67 d=17</p>	<p>F7 - F8 - F90</p> <p>L 2000 - M 2000 L</p>
<p>0807216</p> <p>A  A</p> <p>0907405</p> 	<p>81432306037 8143</p> <p>81432206202</p>	<p>L=500</p> <p>d=19</p> <p>I=100 D=67 d=17</p>	<p>F7 - F8 - F 90 - F 2000</p> <p>L 2000 - M 2000 L</p>
<p>0807407</p> <p>A  A</p> <p>0907407</p> <p>A </p>	<p>81432206382 81432206272 81432206305 81432209267 81432206267 81432206401 81432206236 81432209236 81432206304 81432209272 81432206380 81432206229</p> <p>85432206002 8543</p>	<p>T=48 L=572 I=130 d=19</p> <p>I=130 D=74,9 d=19</p>	<p>TGA - TGS - TGX</p>
<p>0807559</p> <p>A  A</p>	<p>81432206129</p>	<p>L=571</p> <p>d=19</p>	<p>F 2000 M 2000 TGA</p>





BARRE DI REAZIONE - TORQUE RODS

RIF. OCAP OCAP REF.	RIF. ORIG O.E. NUMBER	NOTE REMARKS	MODELLO / DESCRIZIONE MODEL / DESCRIPTION
<p>0907258</p>  <p>A</p> <p>0907757</p>  <p>A</p>	<p>81432206108 8143</p> <p>81432206108</p>	<p>p=30 l=130 D=65 d=19</p> <p>D=65</p>	
<p>0807533</p>  <p>A B</p> <p>0907533</p>  <p>A</p> <p>0907534</p>  <p>B</p>	<p>81432706078 81432706076 81432706074 81432706034 81432706054 81432706082</p> <p>81953016132 03304800A 0005861035</p> <p>81953016133</p>	<p>L=621 d=23</p> <p>L=61 IK=46 D=80</p> <p>p=35 l=152 D=80 d=23</p>	<p>TGA</p>
<p>0807807</p>  <p>A</p> <p>0907258</p>  <p>A</p>	<p>81432206174</p> <p>81432206108 8143</p>	<p>T=50 L=644</p> <p>p=30 l=130 D=65 d=19</p>	<p>M2000</p>



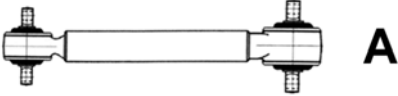
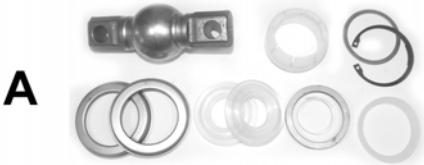

BARRE DI REAZIONE - TORQUE RODS

RIF. OCAP OCAP REF.	RIF. ORIG O.E. NUMBER	NOTE REMARKS	MODELLO / DESCRIZIONE MODEL / DESCRIPTION
<p>0807811</p> <p>A  A</p>	<p>81432206067 81432206092 81432209092 81432206120 81432206090</p>	<p>L=590 d=19</p>	TGA
<p>0907259</p> <p>A  A</p>	<p>81432206055 81432206073 81432206107 81432206250 81953020041</p>	<p>p=30 l=130 D=70 d=19</p>	
<p>0807817</p> <p>A  A</p>	<p>81432206260 8143</p>	<p>T=48 L=941 l=115 d=17</p>	TGA - TGS - TGX
<p>0907528</p> <p>A  A</p>	<p>81432306051 81432306068 81432706064 81432206244</p>	<p>p=24 l=115 D=75 d=17</p>	
<p>0807820</p> <p>A  A</p>	<p>81432206247 81432206341 81432206342</p>	<p>T=50 L=414 l=130 d=23</p>	TGA - TGS - TGX
<p>0907820</p> <p>A  A</p>	<p>81432206322</p>	<p>p=30 l=130 D=72 d=23</p>	
<p>0807821</p> <p>A  A</p>	<p>81432206161 8143</p>	<p>T=50 L=531 l=130 d=19</p>	TGA
<p>0907259</p> <p>A  A</p>	<p>81432206055 81432206073 81432206107 81432206250 81953020041</p>	<p>p=30 l=130 D=70 d=19</p>	



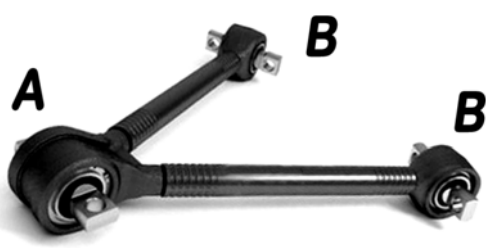

BARRE DI REAZIONE - TORQUE RODS

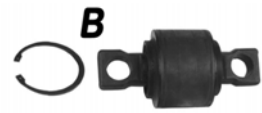
RIF. OCAP OCAP REF.	RIF. ORIG O.E. NUMBER	NOTE REMARKS	MODELLO / DESCRIZIONE MODEL / DESCRIPTION
<p>0807824</p> 	<p>81432206140 8143</p>	<p>L=596 d2=18,5 d1=19</p>	<p>M2000</p>
<p>0907258</p> 	<p>81432206108 8143</p>	<p>p=30 l=130 D=65 d=19</p>	
<p>0907757</p> 	<p>81432206108</p>	<p>D=65</p>	<p>senza perno (without pin)</p>
<p>0807839</p> 	<p>81432706087 81432706088 81432706094 81432706095 81432706137 81432706150</p>	<p>T=48 L=627</p>	<p>TGA - TGS - TGX</p>
<p>0907774</p> 	<p>81432706110</p>	<p>p=24 l=152 D1=100 d=25</p>	
<p>0907907</p> 	<p>81432706105 8143</p>	<p>p=24,3 l=130 d=25</p>	







BARRE DI REAZIONE - TORQUE RODS

RIF. OCAP OCAP REF.	RIF. ORIG O.E. NUMBER	NOTE REMARKS	MODELLO / DESCRIZIONE MODEL / DESCRIPTION
<p>0807840</p> 	<p>81432706096 81432206221 81432706114 81432706121</p>	<p>T=48 L=627</p>	<p>TGA - TGS - TGX</p>
<p>0907533</p> 	<p>81953016132 03304800A 0005861035</p>	<p>L=61 IK=46 D=80</p>	
<p>0907840</p> 	<p>81432706123 81432706126 81432706118</p>	<p>p=30 l=130 D=85 d=23</p>	
<p>0807841</p> 	<p>81432706137 81432706116 81432706150 81432706151</p>	<p>T=48 L=627</p>	<p>F2000 TGA - TGS - TGX</p>
<p>0907774</p> 	<p>81432706110</p>	<p>p=24 l=152 D1=100 d=25</p>	
<p>0907907</p> 	<p>81432706105 8143</p>	<p>p=24,3 l=130 d=25</p>	

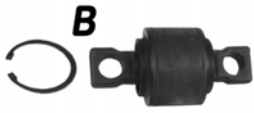





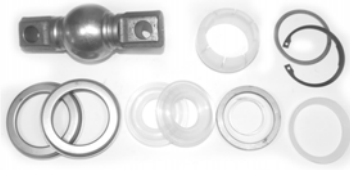

BARRE DI REAZIONE - TORQUE RODS

RIF. OCAP OCAP REF.	RIF. ORIG O.E. NUMBER	NOTE REMARKS	MODELLO / DESCRIZIONE MODEL / DESCRIPTION
<p>0807842</p> 	<p>81432706097 81432706113 81432706135 81432706160 81432706161</p>	<p>T=46 L=627</p>	<p>TGA- TGS - TGX</p>
<p>0807894</p> 	<p>81432206268 81432206236 81432206267 81432206272 81432206229 81432209236 81432206401 81432209272 81432206380 81432209297 81432206305 81432206270 81432206304 81432206382</p>	<p>T=52 L=572</p>	<p>TGA - TGS - TGX</p>
<p>0907407</p> 	<p>85432206002 8543</p>	<p>I=130 D=74,9 d=19</p>	
<p>0807906</p> 	<p>81432206196 81432206232 81432206233</p>	<p>T=48 L=596 d=19</p>	<p>TGA - TGS - TGX</p>
<p>0807907</p> 	<p>81432706117 8143</p>	<p>T=58 L=627 d=19</p>	<p>TGA - TGS - TGX</p>







BARRE DI REAZIONE - TORQUE RODS

RIF. OCAP OCAP REF.	RIF. ORIG O.E. NUMBER	NOTE REMARKS	MODELLO / DESCRIZIONE MODEL / DESCRIPTION
<p>0907533</p>  <p>0907907</p> 	<p>81953016132 03304800A 0005861035</p> <p>81432706105 8143</p>	<p>L=61 IK=46 D=80</p> <p>p=24,3 l=130 d=25</p>	
<p>0809420</p>  <p>0909992</p> 	<p>81432206327 81432206271 81432206282 81432206314</p> <p>81432206285</p>	<p>L=572</p> <p>p=24 l=130 D=85 d=25</p>	TGA - TGS - TGX
<p>0809446</p>  <p>0907407</p> 	<p>81432206270</p> <p>85432206002 8543</p>	<p>L=572 l=130 d=19</p> <p>l=130 D=74,9 d=19</p>	TGA - TGS - TGX
<p>0809988</p> 	<p>81432706145 82432706005 81432706147 81432701601 81432706146 82432706007</p>	<p>T=60 L=622 l=130 d=24</p>	TGA - TGS - TGX

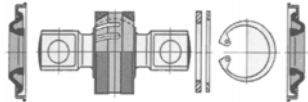
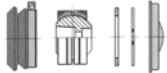

KIT DI SOSPENSIONE - SUSPENSION KITS

RIF. OCAP OCAP REF.	RIF. ORIG O.E. NUMBER	NOTE REMARKS	MODELLO / DESCRIZIONE MODEL / DESCRIPTION
0907258 	81432206108 8143	p=30 l=130 D=65 d=19	L2000 M2000 TGA - TGS - TGX
0907259 	81432206055 81432206073 81432206107 81432206250 81953020041	p=30 l=130 D=70 d=19	L2000 M2000 TGA - TGS - TGX
0907327 	81432306061 81432706091 85432206002	p=24 l=130 D1=75 d=19	TGA - TGS - TGX
0907407 	85432206002 8543	l=130 D=74,9 d=19	TGA - TGS - TGX
0907525 	81432706080		TGA - TGS - TGX
0907528 	81432306051 81432306068 81432706064 81432206244	p=24 l=115 D=75 d=17	M2000 TGA - TGS - TGX
0907529 	81432706079 8143		TGA
0907533 	81953016132 03304800A 0005861035	L=61 lK=46 D=80	TGA - TGS - TGX





KIT DI SOSPENSIONE - SUSPENSION KITS

RIF. OCAP OCAP REF.	RIF. ORIG O.E. NUMBER	NOTE REMARKS	MODELLO / DESCRIZIONE MODEL / DESCRIPTION
0907534 	81953016133	p=35 l=152 D=80 d=23	TGA
0907683 	81953016132 81432706080 81432706122	D=80 IK=46	TGA - TGS - TGX
0907757 	81432206108	D=65	M2000 F 2000 M 2000 TGA
0907774 	81432706110	p=24 l=152 D1=100 d=25	TGA - TGS - TGX
0907820 	81432206322	p=30 l=130 D=72 d=23	TGA - TGS - TGX
0907840 	81432706123 81432706126 81432706118	p=30 l=130 D=85 d=23	TGA - TGS - TGX
0907907 	81432706105 8143	p=24,3 l=130 d=25	TGA - TGS - TGX
0909992 	81432206285	p=24 l=130 D=85 d=25	TGA - TGS - TGX







TESTE COMANDO CAMBIO - GEAR BOX CONTROL BALL JOINTS

RIF. OCAP OCAP REF.	RIF. ORIG O.E. NUMBER	NOTE REMARKS	MODELLO / DESCRIZIONE MODEL / DESCRIPTION
<p>0187228</p> 	81953016169	<p>L=85</p> <p>M=14x1,5 RHT</p>	M 2000
<p>0287229</p> 	81953016170	<p>L=55</p> <p>M=12x1,75 RHT</p>	<p>L 2000</p> <p>M 2000</p> <p>TGL</p> <p>TGM</p>
<p>0297229</p> 	<p>81953016063</p> <p>81953016131</p> <p>81953016171</p> <p>81953016174</p>	<p>L=55</p> <p>M=12x1,75 LHT</p>	<p>L 2000</p> <p>M 2000</p> <p>TGL</p> <p>TGM</p>

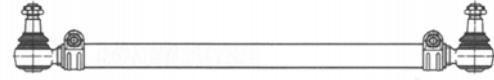

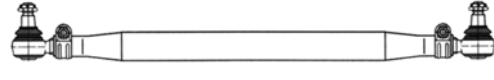

COMPONENTI - COMPONENTS

RIF. OCAP OCAP REF.	RIF. ORIG O.E. NUMBER	NOTE REMARKS	MODELLO / DESCRIZIONE MODEL / DESCRIPTION
1216302 	81437220062 8143		
1216303 	81437040074		
1216304 	81962100450 81437220022 81437220038 81962100469		
1216305 	81437220063 81437220039 81437220021		
1216306 	81437040077		

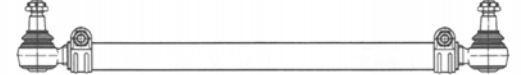

BARRE ACCOPPIAMENTO - TIE RODS

RIF. OCAP OCAP REF.	RIF. ORIG O.E. NUMBER	NOTE REMARKS	MODELLO / DESCRIZIONE MODEL / DESCRIPTION
<p>0506586</p>  <p>0186424 0196424 M=30x1,5 RHT M=30x1,5 LHT</p>	<p>6773300303 67733</p>	<p>L=1562</p>	<p>LK/LN2: 817/L/LO-1114/K 1117/L/LO/K/S-1120/F 1124/F-1314/K/KO-1317/K/KO/LS 1320/L-1324/L-1514/K</p>
<p>0507436</p>  <p>0186551 0196961 M=30x1,5 RHT M=30x1,5 LHT</p>	<p>9493301003 9493301103 9493301703</p>	<p>T=50 L=1596</p>	<p>ACTROS - ACTROS MP2-MP3 AXOR 2</p>
<p>0507437</p>  <p>0186598 M=30x1,5 RHT</p>	<p>9443301703 62533</p>	<p>T=58 L=1588</p>	<p>ACTROS - ACTROS MP2 - MP3 ATEGO AXOR 2</p>
<p>0507587</p>  <p>0186551 0196961 M=30x1,5 RHT M=30x1,5 LHT</p>	<p>0014601505 0014607305 0034603305 3754601605</p>	<p>T=36 L=733</p>	<p>ACTROS - ACTROS MP2 - MP3 AXOR 2</p>
<p>0507591</p>  <p>0186551 0196961 M=30x1,5 RHT M=30x1,5 LHT</p>	<p>9493300203 9493300303 9493300903 9493300803</p>	<p>T=50 L=1615</p>	<p>ACTROS - ACTROS MP2 - MP3 ATEGO AXOR 2</p>
<p>0507603</p>  <p>0186551 M=30x1,5 RHT</p>	<p>9493300603 9493300703 9493301503 9493301603 9493302003 9493302403</p>	<p>T=52 L=1687</p>	<p>ACTROS - ACTROS MP2 - MP3 ATEGO AXOR - AXOR 2</p>

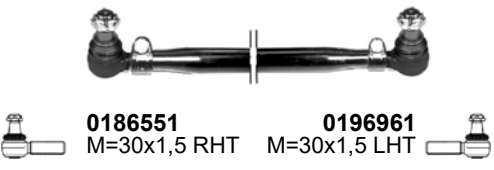
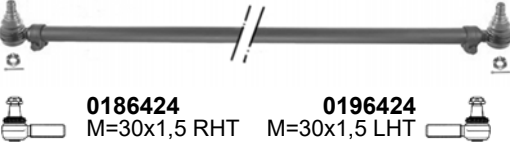

BARRE ACCOPPIAMENTO - TIE RODS

RIF. OCAP OCAP REF.	RIF. ORIG O.E. NUMBER	NOTE REMARKS	MODELLO / DESCRIZIONE MODEL / DESCRIPTION
<p>0507610</p>  <p>0186424 0196424 M=30x1,5 RHT M=30x1,5 LHT</p>	<p>3913300603 3913300803 3913301003 3913301203</p>	<p>T=40 L=1190</p>	<p>MK - NG - SK</p>
<p>0507633</p>  <p>0186551 M=30x1,5 RHT</p>	<p>9423300203 9423300103 9423300003 9423301103</p>	<p>T=52 L=1735</p>	<p>ACTROS - ACTROS MP2 - MP3 ATEGO AXOR2 ECONIC</p>
<p>0507643</p>  <p>0186551 0196961 M=30x1,5 RHT M=30x1,5 LHT</p>	<p>9413300503 9413300203 9413300003 9413300103 9413300303</p>	<p>T=50 L=1735</p>	<p>ACTROS - ACTROS MP2 - MP3 ATEGO AXOR 2</p>
<p>0507651</p>  <p>0186551 0196961 M=30x1,5 RHT M=30x1,5 LHT</p>	<p>9453300503 9453300203 9453300303</p>	<p>T=40 L=1465</p>	<p>ACTROS - ACTROS MP2 - MP3 ATEGO ECONIC</p>
<p>0507916</p>  <p>0187916 M30x1,5 RHT</p>	<p>9453300003 9453300103 9453300403 9453300603</p>	<p>T=62 L=1735</p>	<p>ACTROS - ACTROS MP2 - MP3 ATEGO ECONIC</p>
<p>0507975</p>  <p>0186598 0196598 M=30x1,5 RHT M=30x1,5 LHT</p>	<p>9753302503 9753300803 9753300303 9753300203</p>	<p>T=40 L=1607</p>	<p>ATEGO - ATEGO 2 - 3</p>





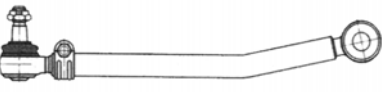
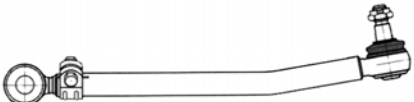
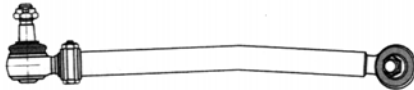
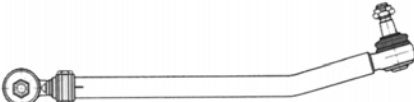

BARRE ACCOPPIAMENTO - TIE RODS

RIF. OCAP OCAP REF.	RIF. ORIG O.E. NUMBER	NOTE REMARKS	MODELLO / DESCRIZIONE MODEL / DESCRIPTION
<p>0508967</p>  <p>0186551 M=30x1,5 RHT 0196961 M=30x1,5 LHT</p>	<p>6253300603 9423300903 9423300503 6253302003 6253302703 9423301903</p>	<p>T=50 L=1565</p>	<p>ACTROS ATEGO AXOR 2</p>
<p>0509391</p>  <p>0186424 M=30x1,5 RHT 0196424 M=30x1,5 LHT</p>	<p>9703300003</p>	<p>T=40 L=1640</p>	<p>ATEGO - ATEGO 2 - 3</p>
<p>0509442</p> 	<p>9603300403</p>	<p>T=52 L=1685</p>	<p>ACTROS MP4-MP5 ECONIC</p>

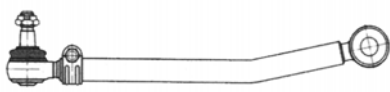





TIRANTI LONGITUDINALI - DRAG LINKS

RIF. OCAP OCAP REF.	RIF. ORIG O.E. NUMBER	NOTE REMARKS	MODELLO / DESCRIZIONE MODEL / DESCRIPTION
<p>0506575</p>  <p>0186598 M=30x1,5 RHT</p>	<p>6204602805 6204600005 6204602005 6204603705 3933200632 3874600405 3874605005</p>	<p>L=885</p>	<p>ACTROS-ATEGO I-ATEGO II ECONIC-NG-MK-SK</p>
<p>0506576</p>  <p>0187146 M=30x1,5 RHT</p>	<p>6754602205</p>	<p>T=40 L=780</p>	<p>LK - LN2 (-98)</p>
<p>0506577</p>  <p>0187146 M=30x1,5 RHT</p>	<p>6764601105</p>	<p>T=40 L=780</p>	<p>LK - LN2 (-98)</p>
<p>0506578</p>  <p>0186598 M=30x1,5 RHT</p>	<p>6194605205 6194602505 6194602905</p>	<p>T=42 L=860</p>	<p>MK - NG - SK</p>
<p>0506579</p>  <p>0187146 M=30x1,5 RHT</p>	<p>3874604805 3874600005 3874604905</p>	<p>L=880</p>	<p>NG: 1626S-1632S-1719S-1919S-1926S 1932S-2626S (6x4)-1935-2226-2232 2626K (6x4)-2632-3332</p>
<p>0506580</p>  <p>0187146 M=30x1,5 RHT</p>	<p>3874604405 3874600605 3874604505</p>	<p>L=865</p>	<p>NG: 1626/LS/S-1632/LS/S-1719/S 1919S-1926S-1932S-2026(6x2) (6x4) 2032(6x2)(6x4)-2226L/S(6x2)-2232LS(6x4) 2626S/K(6x4)-2632/S(6x4)-3332</p>







TIRANTI LONGITUDINALI - DRAG LINKS

RIF. OCAP OCAP REF.	RIF. ORIG O.E. NUMBER	NOTE REMARKS	MODELLO / DESCRIZIONE MODEL / DESCRIPTION
<p>0506581</p>  <p>0187146 M=30x1,5 RHT</p>	<p>6754602405 6754601205 6754601805 6754603005</p>	<p>T=40 L=727</p>	<p>LK/LN2</p>
<p>0506582</p>  <p>0186551 M=30x1,5 RHT</p>	<p>14602905 0014603</p>	<p>L=840</p>	<p>MK - SK</p>
<p>0506583</p>  <p>0186547 M=30x1,5 RHT</p>	<p>6734600605</p>	<p>T=36 L=725</p>	<p>LK - LN2 (-98)</p>
<p>0506584</p>  <p>0186547 M=30X1,5 RHT</p>	<p>3834604505 3834601605 3834602405 3834600805</p>	<p>L=890</p>	<p>NG</p>
<p>0506585</p>  <p>0186598 M=30x1,5 RHT</p>	<p>0004607105 0004607205 0014606705</p>	<p>T=42 L=879</p>	<p>ACTROS AXOR - AXOR 2</p>
<p>0506962</p>  <p>0186598 M=30x1,5 RHT</p>	<p>6474600005 3874600705 6474600105 3874603305 3874601405 3874603205</p>	<p>T=40 L=865</p>	<p>MK - NG</p>



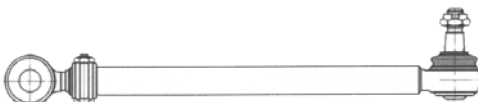

TIRANTI LONGITUDINALI - DRAG LINKS

RIF. OCAP OCAP REF.	RIF. ORIG O.E. NUMBER	NOTE REMARKS	MODELLO / DESCRIZIONE MODEL / DESCRIPTION
<p>0506963</p>  <p>0187146 M=30x1,5 RHT</p>	<p>3834604405 3834601405 3834602305 3834600605</p>	<p>L=890</p>	<p>MK - ATEGO I - NG</p>
<p>0507439</p>  <p>0186424 M=30x1,5 RHT</p>	<p>9724601405 97246</p>	<p>T=40 L=837</p>	<p>ATEGO - ATEGO 2</p>
<p>0507611</p>  <p>0186424 M=30x1,5 RHT</p>	<p>4244600305 4274600005 4274600105 4274600305 4274600405</p>	<p>T=38 L=877</p>	<p>UNIMOG</p>
<p>0507613</p>  <p>0186424 M=30x1,5 RHT</p>	<p>9704600905 97046</p>	<p>T=42 L=846</p>	<p>ATEGO - ATEGO 2</p>
<p>0507614</p>  <p>0187959 M=30x1,5 RHT</p>	<p>0034605705 0024609605 0024609705</p>	<p>T=40 L=858</p>	<p>ACTROS - ACTROS MP2-MP3</p>
<p>0507615</p>  <p>0187959 M=30x1,5 RHT</p>	<p>24604905 0024605</p>	<p>T=40 L=895</p>	<p>ATEGO AXOR - AXOR 2</p>



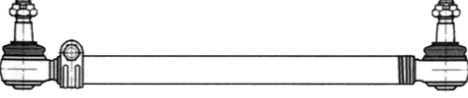



TIRANTI LONGITUDINALI - DRAG LINKS

RIF. OCAP OCAP REF.	RIF. ORIG O.E. NUMBER	NOTE REMARKS	MODELLO / DESCRIZIONE MODEL / DESCRIPTION
<p>0507617</p>  <p>0187959 M=30x1,5 RHT</p>	<p>4054600005 4054600305 4054600605</p>	<p>T=42 L=753</p>	<p>UNIMOG</p>
<p>0507627</p>  <p>0186598 M=30x1,5 RHT</p>	<p>4609905 00046098</p>	<p>L=900</p>	<p>SK</p>
<p>0507630</p>  <p>0187789 M=28x1,5 RHT</p>	<p>0024604405 0024604305 0034604805</p>	<p>T=35 L=879</p>	<p>ACTROS - ACTROS MP2 - MP3 ATEGO 2 AXOR - AXOR 2</p>
<p>0507631</p>  <p>0187959 M=30x1,5 RHT</p>	<p>0024604805 0024604705 0034604905</p>	<p>T=40 L=876</p>	<p>ACTROS - ACTROS MP2 - MP3 AXOR AXOR 2 - ATEGO 2</p>
<p>0507632</p>  <p>0186598 M=30x1,5 RHT</p>	<p>0024606405 0014609805 0014609905</p>	<p>T=38 L=866</p>	<p>ACTROS - ACTROS MP2-MP3</p>
<p>0507639</p>  <p>0187146 M=30x1,5 RHT</p>	<p>6764601905 67646</p>	<p>T=42 L=783</p>	<p>LK/LN 2</p>







TIRANTI LONGITUDINALI - DRAG LINKS

RIF. OCAP OCAP REF.	RIF. ORIG O.E. NUMBER	NOTE REMARKS	MODELLO / DESCRIZIONE MODEL / DESCRIPTION
<p>0507642</p>  <p>0187959 M=30x1,5 RHT</p>	<p>0034601805 0034601905 0034605805</p>	<p>T=42 L=888</p>	<p>ACTROS MP2 - MP3</p>
<p>0507789</p>  <p>0187789 M=28x1,5 RHT</p>	<p>0024604505 0024604605 3754600405</p>	<p>T=36 L=895</p>	<p>ACTROS - ACTROS MP2 - MP3 ATEGO - ATEGO 2 AXOR 2</p>
<p>0507794</p>  <p>0186424 M=30x1,5 RHT</p>	<p>6764603105</p>	<p>T=42 L=783</p>	<p>LK/LN2</p>
<p>0507827</p>  <p>0186598 M=30x1,5 RHT</p>	<p>9724602005 9724601805 0034605905</p>	<p>T=50 L=895</p>	<p>ATEGO - ATEGO 2</p>
<p>0507887</p>  <p>0186598 M=30x1,5 RHT</p>	<p>0034604605 3754600005 9744601005 9744601205</p>	<p>T=50 L=894</p>	<p>ATEGO - ATEGO 2</p>
<p>0507905</p>  <p>0186613 M=28x1,5 RHT</p>	<p>6674601705 66746</p>	<p>T=34 L=504</p>	<p>VARIO</p>

TIRANTI LONGITUDINALI - DRAG LINKS

RIF. OCAP OCAP REF.	RIF. ORIG O.E. NUMBER	NOTE REMARKS	MODELLO / DESCRIZIONE MODEL / DESCRIPTION
<p>0507911</p> 	<p>0014601305 3754601505 0024600505 0014601405 0034603205</p>	<p>T=42 L=1095</p>	<p>ACTROS - ACTROS MP2 - MP3 AXOR 2</p>
<p>0507912</p>  <p>0186551 M=30x1,5 RHT</p>	<p>0024605205</p>	<p>T=38 L=885</p>	<p>ACTROS - ACTROS MP2 - MP3 ATEGO AXOR 2</p>
<p>0507961</p> 	<p>0014601105 0024600405 0034603105</p>	<p>T=42 L=711</p>	<p>ACTROS - ACTROS MP2-MP3</p>
<p>0507962</p>  <p>0186551 M=30x1,5 RHT</p>	<p>0034604205 0024606105 0034606205</p>	<p>T=38 L=958</p>	<p>ACTROS - ACTROS MP2 - MP3 ATEGO AXOR 2</p>
<p>0507963</p>  <p>0186598 M=30x1,5 RHT</p>	<p>0034604705 9744601105 9744601305 0034600705</p>	<p>T=50 L=894</p>	<p>ATEGO - ATEGO 2</p>
<p>0507965</p>  <p>0186551 M=30x1,5 RHT</p>	<p>0034604105 0024605905 0024606005</p>	<p>T=38 L=935</p>	<p>ACTROS - ACTROS MP2 - MP3</p>







TIRANTI LONGITUDINALI - DRAG LINKS

RIF. OCAP OCAP REF.	RIF. ORIG O.E. NUMBER	NOTE REMARKS	MODELLO / DESCRIZIONE MODEL / DESCRIPTION
<p>0507967</p>  <p>0186551 M=30x1,5 RHT</p>	<p>14607105 0004609</p>	<p>T=52 L=904</p>	<p>ACTROS - ACTROS MP2 - MP3</p>
<p>0507968</p>  <p>0186598 M=30x1,5 RHT</p>	<p>0014600705 0014600805 0014607005</p>	<p>T=38 L=888</p>	<p>ACTROS</p>
<p>0507972</p>  <p>0186551 M=30x1,5 RHT</p>	<p>9574600505 95746</p>	<p>T=50 L=860</p>	<p>ECONIC</p>
<p>0508939</p> 	<p>9574600405 95746</p>	<p>T=36 L=387</p>	<p>ECONIC</p>
<p>0508957</p>  <p>0186551 M=30x1,5 RHT</p>	<p>24608605 0024608</p>	<p>T=38 L=883</p>	<p>ACTROS - ACTROS MP2 - MP3</p>
<p>0509461</p>  <p>0186551 M=30x1,5 RHT</p>	<p>24608805 0024608</p>	<p>T=38 L=761</p>	<p>ACTROS - ACTROS MP2 - MP3 AXOR 2</p>

TIRANTI LONGITUDINALI - DRAG LINKS

RIF. OCAP OCAP REF.	RIF. ORIG O.E. NUMBER	NOTE REMARKS	MODELLO / DESCRIZIONE MODEL / DESCRIPTION
<p>0509470</p>  <p>0187686 M=30x1,5 RHT</p>	<p>0034608605</p>	<p>T=46 L=776</p>	<p>ACTROS MP4-MP5</p>







TESTE STERZO - TIE RODS END

RIF. OCAP OCAP REF.	RIF. ORIG O.E. NUMBER	NOTE REMARKS	MODELLO / DESCRIZIONE MODEL / DESCRIPTION
0186424 	0014604448 0023301535 0013300135 0003307335 0013300235 0014603148 14603448 14608348 14608448	L=115 M=30x1,5 RHT	ACTROS ATEGO 2 AXOR UNIMOG
0196424 	0013308835 3023300035 3023300135 3023300335 3023300355 3023300235 14604348 3503307135 3406218 13306635	L=115 M=30x1,5 LHT	ACTROS ATEGO 2 AXOR
0186547 	0013300335	L=115 M=30x1,5 RHT	LK - LN
0196547 	-	L=115 M=30x1,5 LHT	LK - LN
0186551 	0004606848 0014607648 0014601748 0004605748 0004607548 0014600448 14601148 14602448 4607048	L=120 M=30x1,5 RHT	ACTROS - ACTROS MP2 - MP3 ATEGO 2 AXOR
0186598 	0024600148 0004602948 0014601848 0004601048 0004602848 0014602248 14607748	L=120 M=30x1,5 RHT	ATEGO
0196598 	0014603648 0004603548 0014601448 0004603448 0014602348 0014607848	L=120 M=30x1,5 LHT	ATEGO



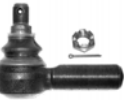



TESTE STERZO - TIE RODS END

RIF. OCAP OCAP REF.	RIF. ORIG O.E. NUMBER	NOTE REMARKS	MODELLO / DESCRIZIONE MODEL / DESCRIPTION
0186612 	0003309735 0003309935 0003383429 0003301235	L=105 M=24x1,5 RHT	VARIO
0196612 	0003301235 0003301335 0003307535 0003307635	L=105 M=24x1,5 LHT	VARIO
0186613 	0003309335 0003301435 0003301535 0003307135 0003309535 0003382129	L=105 M=28x1,5 RHT	VARIO
0186758 	A0003305248 A0003406169 A0003406251	L=135 M=30x1,5 RHT	LK - LN
0187146 	0004602648	L=120 M=30x1,5 RHT	LK - LN - NG
0197146 	0014607448	L=120 M=30x1,5 LHT	LK - LN - NG
0187467 	0004601748	L=135 M=38x1,5 RHT	ACTROS
0197467 	6851490000	L=135 M=38x1,5 LHT	ACTROS

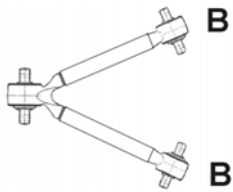

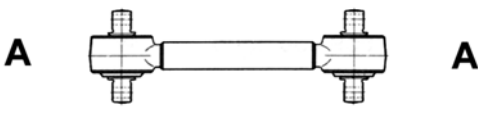

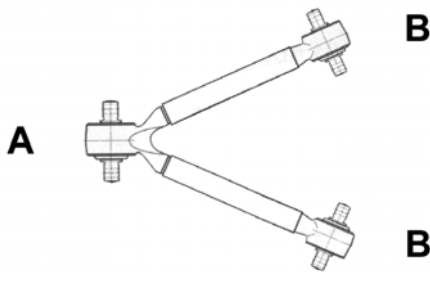

TESTE STERZO - TIE RODS END

RIF. OCAP OCAP REF.	RIF. ORIG O.E. NUMBER	NOTE REMARKS	MODELLO / DESCRIZIONE MODEL / DESCRIPTION
0187789 	0014604148 A0014608948	L=141 M=28X1,5 RHT	ACTROS - ACTROS MP2 - MP3 ATEGO 2 AXOR - AXOR 2
0187916 	0014602948	L=146 M=30x1,5 RHT	ACTROS - ACTROS MP2 - MP3 ATEGO ECONIC
0187959 	0014609948 0014605148 0014608648 0014603848 0014604848	L=115 M=30x1,5 RHT	ACTROS - ACTROS MP2-MP3-MP4-MP5 AXOR
0196961 	0004606948 0014607948 0014602548 0014600548 0004606148 0004607148	L=120 M=30x1,5 LHT	ACTROS - ACTROS MP2 - MP3 ATEGO 2 AXOR
0287684 	0004604948	L=95 M=26x1,5 RHT	ACTROS MP 2 - MP 3 ATEGO - ATEGO 2 AXOR 2
0288930 	14601648 00246	L=75 M=26x1,5 RHT	ACTROS MP2 - MP3 AXOR 2



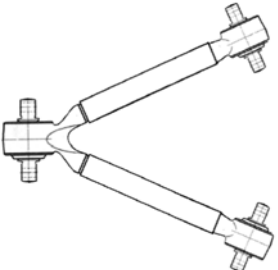

BARRE DI REAZIONE - TORQUE RODS

RIF. OCAP OCAP REF.	RIF. ORIG O.E. NUMBER	NOTE REMARKS	MODELLO / DESCRIZIONE MODEL / DESCRIPTION
<p>0807599</p> 	<p>9423500505 9423501205 9423500805</p>	<p>L=622</p>	<p>ACTROS ACTROS MP2 - MP3 - MP4 - MP5 AXOR 2 ECONIC 2</p>
<p>0907599</p> 	<p>0003502505</p>	<p>p=24 l=130 D1=75 d=25</p>	
<p>0807611</p> 	<p>6593501106 3953500006 6243500006 6593503406</p>	<p>L=579 d=21</p>	<p>NG - SK</p>
<p>0907330</p> 	<p>3500413 00058612</p>	<p>p=24 l=152 D=80 d=21</p>	
<p>0807634</p> 	<p>9443500005 9473500105 9443500305 9423501005 9423501505 9473500705 9473501005</p>	<p>L=622 d=25</p>	<p>ACTROS - ACTROS MP2 - MP3 - MP4 - MP5 ATEGO AXOR 2 ECONIC</p>
<p>0907634</p> 	<p>0003504405 0003504005 0003502305</p>	<p>p=24 l=152 D1=85 d=25</p>	
<p>0907599</p> 	<p>0003502505</p>	<p>p=24 l=130 D1=75 d=25</p>	





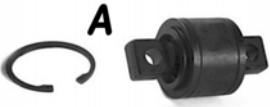
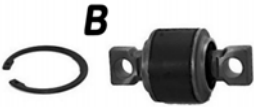

BARRE DI REAZIONE - TORQUE RODS

RIF. OCAP OCAP REF.	RIF. ORIG O.E. NUMBER	NOTE REMARKS	MODELLO / DESCRIZIONE MODEL / DESCRIPTION
0807635  0907635 	9453300007 0003301411	L=850 d=17 p=20 l=100 D1=67 d=17	ACTROS - ACTROS MP2 - MP3 ATEGO - ATEGO 2
0807636  0907635 	9413300007 0003301411	L=845 d=17 p=20 l=100 D1=67 d=17	ACTROS - ACTROS MP2 - MP3 ATEGO AXOR 2 ECONIC
0807669  0907547 	9483501205 9483501305 9483500805 9473500005 9473500605 9483500006 8483500106 9483502005 9483502405 0003502705	T=52 L=565 d=21 I=152 D=70 d=21	ACTROS - ACTROS MP2 - MP3 ATEGO AXOR - AXOR 2
0807774 	9483500405 9483503005 9443500505 9473500905	L=622 d=25	ACTROS - ACTROS MP2 - MP3 AXOR - AXOR 2

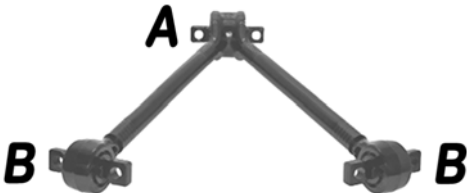

BARRE DI REAZIONE - TORQUE RODS

RIF. OCAP OCAP REF.	RIF. ORIG O.E. NUMBER	NOTE REMARKS	MODELLO / DESCRIZIONE MODEL / DESCRIPTION
<p>0907774</p> 	<p>3502405 00035049</p>	<p>p=24 l=152 D1=100 d=25</p>	
<p>0907599</p> 	<p>0003502505</p>	<p>p=24 l=130 D1=75 d=25</p>	
<p>0807908</p> 	<p>9483502205 94835</p>	<p>T=60 L=621,5</p>	<p>ACTROS - ACTROS MP2 - MP3 AXOR 2</p>
<p>0907908</p> 	<p>0003503605</p>	<p>l=152 p=30 d=25</p>	
<p>0907909</p> 	<p>0003503705</p>	<p>l=130 p=30 d=23</p>	
<p>0808975</p> 	<p>9453500105 9483501005 9483502505</p>	<p>T=52 L=615</p>	<p>ACTROS MP2 - MP3 AXOR 2</p>
<p>0907547</p> 	<p>0003502705</p>	<p>l=152 D=70 d=21</p>	





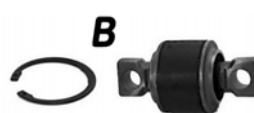



BARRE DI REAZIONE - TORQUE RODS

RIF. OCAP OCAP REF.	RIF. ORIG O.E. NUMBER	NOTE REMARKS	MODELLO / DESCRIZIONE MODEL / DESCRIPTION
<p>0808982</p> 	9483502905	T=46 L=622	ACTROS MP2 - MP3 AXOR 2
<p>0907774</p> 	3502405 00035049	p=24 l=152 D1=100 d=25	
<p>0907609</p> 	0003502205 0003504505 0003503205 0003502505	p=24 l=130 D=62 d=25	
<p>0808986</p> 	9483500905 94835	T=60 L=667	ACTROS - ACTROS MP2 - MP3 AXOR 2
<p>0907908</p> 	0003503605	l=152 p=30 d=25	
<p>0907909</p> 	0003503705	l=130 p=30 d=23	
<p>0808987</p> 	9743500005 9743500405 9743500505	T=46 L=761,70	ATEGO - ATEGO 2 - ATEGO 3





BARRE DI REAZIONE - TORQUE RODS

RIF. OCAP OCAP REF.	RIF. ORIG O.E. NUMBER	NOTE REMARKS	MODELLO / DESCRIZIONE MODEL / DESCRIPTION
<p>0907622</p> <p>A </p>	<p>3502105 00035046</p>	<p>p=24 l=152 D1=75 d=25</p>	
<p>0907909</p> <p>B </p>	<p>0003503705</p>	<p>l=130 p=30 d=23</p>	
<p>0809444</p> 	<p>9603500906</p>	<p>T=46 L=532 l=130 d=21</p>	<p>ACTROS MP4 - MP5</p>



KIT DI SOSPENSIONE - SUSPENSION KITS

RIF. OCAP OCAP REF.	RIF. ORIG O.E. NUMBER	NOTE REMARKS	MODELLO / DESCRIZIONE MODEL / DESCRIPTION
0907547 	0003502705	l=152 D=70 d=21	ACTROS - ACTROS MP2 - MP3 - ATEGO AXOR - AXOR 2
0907330 	3500413 00058612	p=24 l=152 D=80 d=21	NG - SK
0907599 	0003502505	p=24 l=130 D1=75 d=25	ACTROS ACTROS MP2 - MP3 - MP4 - MP5 AXOR 2 ECONIC 2
0907609 	0003502205 0003504505 0003503205 0003502505	p=24 l=130 D=62 d=25	ACTROS MP2 - MP3 AXOR 2
0907622 	3502105 00035046	p=24 l=152 D1=75 d=25	ATEGO - ATEGO 2 - ATEGO 3
0907908 	0003503605	l=152 p=30 d=25	ATEGO - ATEGO 2 - ATEGO 3
0907634 	0003504405 0003504005 0003502305	p=24 l=152 D1=85 d=25	ACTROS ACTROS MP2 - MP3 - MP4 - MP5 ATEGO AXOR 2 ECONIC
0907635 	0003301411	p=20 l=100 D1=67 d=17	ACTROS - ACTROS MP2 - MP3 ATEGO AXOR 2 ECONIC
0907774 	3502405 00035049	p=24 l=152 D1=100 d=25	ACTROS - ACTROS MP2 - MP3 AXOR - AXOR 2

KIT DI SOSPENSIONE - SUSPENSION KITS

RIF. OCAP OCAP REF.	RIF. ORIG O.E. NUMBER	NOTE REMARKS	MODELLO / DESCRIZIONE MODEL / DESCRIPTION
0907908 	0003503605	l=152 p=30 d=25	ACTROS - ACTROS MP2 - MP3 AXOR 2
0907909 	0003503705	l=130 p=30 d=23	ACTROS - ACTROS MP2 - MP3 AXOR 2
0907984 	3502005 00035047	p=23 l=130 D1=67 d=23	ACTROS - ACTROS MP2 - MP3 ATEGO - ATEGO 2 AXOR 2
0908991 	0003503105 0003502305 0003504405	p=24 l=152 D1=85 d=25	ACTROS - ATEGO 2 AXOR



STABILIZZATORI - STABILIZERS

RIF. OCAP OCAP REF.	RIF. ORIG O.E. NUMBER	NOTE REMARKS	MODELLO / DESCRIZIONE MODEL / DESCRIPTION
0508968 	0003220323 0003220623 3753220423	T=58 L=1815	ACTROS - ACTROS MP2-MP3 AXOR 2
0508969 	3220423 00032207	T=60 L=1815	ACTROS - ACTROS MP2-MP3





KIT PERNO FUSO - KING PIN SET

RIF. OCAP OCAP REF.	RIF. ORIG O.E. NUMBER	NOTE REMARKS	MODELLO / DESCRIZIONE MODEL / DESCRIPTION
<p>0927436</p> 	<p>3913300019 3915860033 3895860033</p>	<p>L=222,5 D=50/51</p>	<p>ASSE ANTERIORE/FRONT AXLE: ACTROS - ATEGO - ATEGO 2 - ECONIC MK - NG - SK</p>



BARRE ACCOPPIAMENTO - TIE RODS

RIF. OCAP OCAP REF.	RIF. ORIG O.E. NUMBER	NOTE REMARKS	MODELLO / DESCRIZIONE MODEL / DESCRIPTION
<p>0506588</p>  <p>  0186592 0196592  M=22x1,5 RHT M=22x1,5 LHT </p>	<p>11200265-0</p>	<p>T=28 L=1385</p>	<p>ECO-T</p>



TIRANTI LONGITUDINALI - DRAG LINKS

RIF. OCAP OCAP REF.	RIF. ORIG O.E. NUMBER	NOTE REMARKS	MODELLO / DESCRIZIONE MODEL / DESCRIPTION
<p>0506590</p> 	<p>11200454-0 112004540 485109X101 485109X100 48510D8600 48510LA20A</p>	<p>T=36 L=780</p>	<p>ATLEON</p>
<p>0506591</p>  <p> 0186592 M=22x1,5 RHT</p>	<p>11505036-0</p>	<p>T=36 L=755</p>	<p>ECO-T TRADE</p>
<p>0509411</p>  <p> 0186592 M=22x1,5 RHT</p>	<p>48510-F3900 48510-F3901 48510-LA21D 48510F3900 48510F3901 48510LA21D</p>	<p>T=36 L=640</p>	<p>CABSTAR</p>





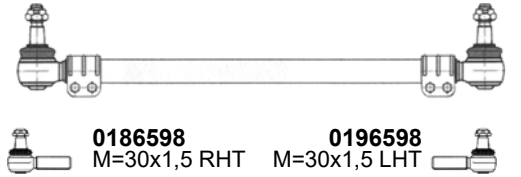
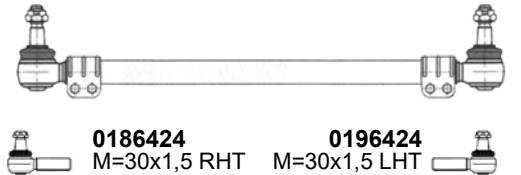
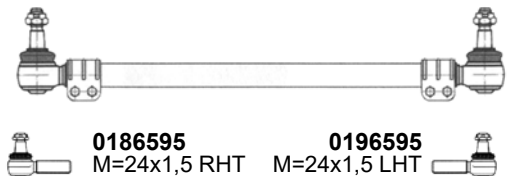

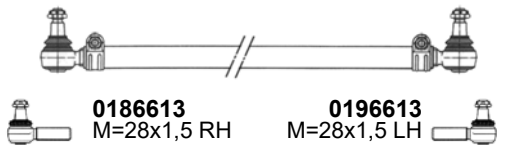
TESTE STERZO - TIE RODS END

RIF. OCAP OCAP REF.	RIF. ORIG O.E. NUMBER	NOTE REMARKS	MODELLO / DESCRIZIONE MODEL / DESCRIPTION
0186592 	11200360-0 11200360-0A 11200360-0B 485279X62A 485139X200	L=95 M=22x1,5 RHT	ATLEON CABSTAR ECO-T TRADE
0196592 	11200361-0 11200361-0A 11200361-0B 486479X62A 485139X201	L=95 M=22x1,5 LHT	ATLEON CABSTAR ECO-T



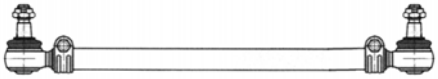



BARRE ACCOPPIAMENTO - TIE RODS

RIF. OCAP OCAP REF.	RIF. ORIG O.E. NUMBER	NOTE REMARKS	MODELLO / DESCRIZIONE MODEL / DESCRIPTION
0506026 	1146170 0001146170	T=52 L=797	
0506695  <p> 0186598 0196598 M=30x1,5 RHT M=30x1,5 LHT </p>	5000786902 50101	T=48 L=1690	MIDLINER MIDLUM
0506697  <p> 0186424 0196424 M=30x1,5 RHT M=30x1,5 LHT </p>	5000613837	T=40 L=1510	MIDLINER
0506699  <p> 0186595 0196595 M=24x1,5 RHT M=24x1,5 LHT </p>	5000446681	T=30 L=1415	MIDLINER
0506754  <p> 0186598 0196598 M=30x1,5 RHT M=30x1,5 LHT </p>	5010308082	L=1620	PREMIUM - KERAX
0506904  <p> 0186613 0196613 M=28x1,5 RH M=28x1,5 LH </p>	86012923 42037386 7166166	L=1404	MIDLINER M/S

BARRE ACCOPPIAMENTO - TIE RODS

RIF. OCAP OCAP REF.	RIF. ORIG O.E. NUMBER	NOTE REMARKS	MODELLO / DESCRIZIONE MODEL / DESCRIPTION
<p>0506939</p>  <p>0186598 M=30x1,5 RHT 0196598 M=30x1,5 LHT</p>	<p>5000613598</p>	<p>T=40 L=1736</p>	<p>MIDLUM</p>
<p>0507849</p>  <p>0186598 M=30x1,5 RHT 0196598 M=30x1,5 LHT</p>	<p>5010439631 5010098467 5010145584</p>	<p>T=48 L=1752</p>	<p>KERAX PREMIUM</p>
<p>0507855</p>  <p>0186598 M=30x1,5 RHT 0196598 M=30x1,5 LHT</p>	<p>5010566059</p>	<p>T=48 L=1720</p>	<p>PREMIUM KERAX</p>
<p>0507856</p>  <p>0187723 M=30x1,5 RHT</p>	<p>5010566064 50104</p>	<p>T=52 L=1720</p>	<p>PREMIUM</p>
<p>0507858</p>  <p>0187723 M=30x1,5 RHT</p>	<p>5010566063 50104</p>	<p>T=52 L=1758</p>	<p>MAGNUM PREMIUM</p>
<p>0507865</p>  <p>0187723 M=30x1,5 RHT</p>	<p>5010439023 5010291903 5010566062</p>	<p>T=52 L=1560</p>	<p>MIDLINER</p>











BARRE ACCOPPIAMENTO - TIE RODS

RIF. OCAP OCAP REF.	RIF. ORIG O.E. NUMBER	NOTE REMARKS	MODELLO / DESCRIZIONE MODEL / DESCRIPTION
<p>0508736</p>  <p>0187723 M=30x1,5 RHT</p>	<p>5001868363 7421560957 5010587004 5010600822</p>	<p>T=60 L=1655</p>	<p>PREMIUM 2 MAGNUM</p>
<p>0509435</p>  <p>0188994 M=30x1,5 RHT</p>	<p>5010630434</p>	<p>T=58 L=1818</p>	<p>MAGNUM - PREMIUM 2</p>
<p>0509440</p>  <p>0187723 M=30x1,5 RHT</p>	<p>7422163636</p>	<p>T=60 L=1766</p>	<p>MAGNUM</p>
<p>0509468</p> 	<p>7422159764</p>	<p>T=60 L=1671</p>	<p>SERIE T</p>
<p>0509473</p> 	<p>7422159755 74211</p>	<p>T=60 L=1693</p>	<p>SERIE T</p>
<p>0509911</p>  <p>0187723 M=30x1,5 RHT</p>	<p>5001868366</p>	<p>T=60 L=1686</p>	<p>PREMIUM 2 SERIE C</p>
<p>0509912</p>  <p>0186424 M=30x1,5 RHT</p>	<p>1164684</p>	<p>T=42 L=825</p>	<p>-</p>

BARRE ACCOPPIAMENTO - TIE RODS

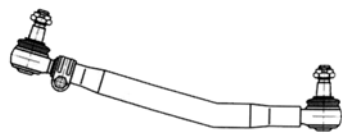
RIF. OCAP OCAP REF.	RIF. ORIG O.E. NUMBER	NOTE REMARKS	MODELLO / DESCRIZIONE MODEL / DESCRIPTION
<p>0509914</p> 	<p>7420581086</p>	<p>T=42 L=1669</p>	<p>SERIE C - SERIE K - SERIE T</p>







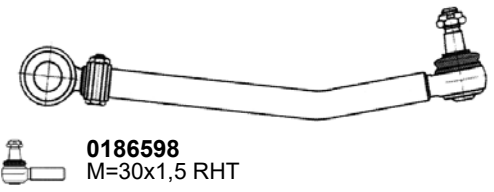
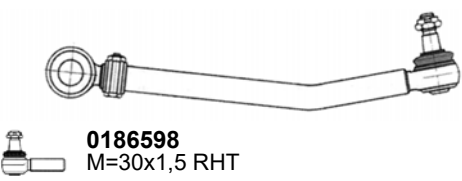
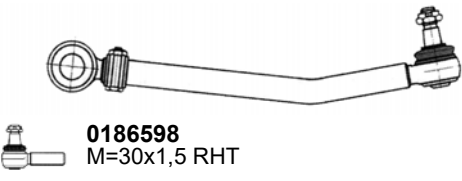
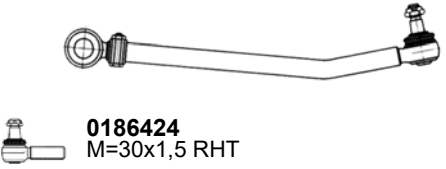
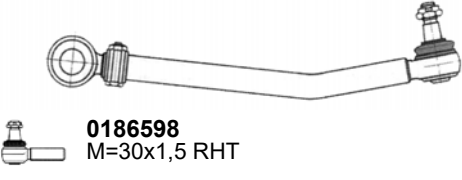
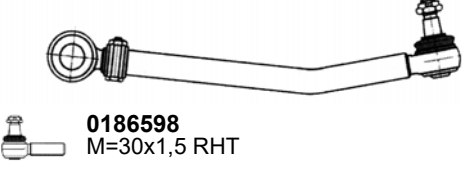



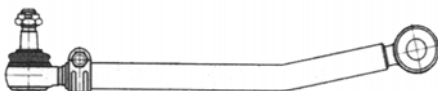

TIRANTI LONGITUDINALI - DRAG LINKS

RIF. OCAP OCAP REF.	RIF. ORIG O.E. NUMBER	NOTE REMARKS	MODELLO / DESCRIZIONE MODEL / DESCRIPTION
0506642   0186598 M=30x1,5 RHT	5010130453 0023123247 5000748868 5000874577 5000748784 5010138446 5010138060 712758 721608 5010138691 5000783889 5000874578 50101030452	L=1012	R 340 Modello unico fino a 05/93 Dopo vedi: 0506678-0506691 RIF.OCAP (Only model to 05/93. After Check For OCAP REF.: 0506678-0506691) MAJOR R
0506676   0186598 M=30x1,5 RHT	5010144552 5000725267 5000787304 5010144549 5000787305 5000787306	L=975	MANAGER G: 270-280-300-330-340 MAXTER G: 230-260-280-300-340
0506677   0186598 M=30x1,5 RHT	5010144556 5000745719 5000791330 5010144551 5010092170 5010092191 5010144557	L=975	MANAGER G MAXTER G
0506678   0186598 M=30x1,5 RHT	5010239340 5010130739 5010239386	L=1018	R - MAJOR R
0506679   0186598 M=30x1,5 RHT	5010060764 50105	T=36 L=720	MAGNUM





TIRANTI LONGITUDINALI - DRAG LINKS

RIF. OCAP OCAP REF.	RIF. ORIG O.E. NUMBER	NOTE REMARKS	MODELLO / DESCRIZIONE MODEL / DESCRIPTION
<p>0506680</p>  <p>0186598 M=30x1,5 RHT</p>	<p>5000787472 50101</p>	<p>L=840</p>	<p>C 260-300-340</p>
<p>0506681</p>  <p>0186598 M=30x1,5 RHT</p>	<p>5010294287</p>	<p>T=50 L=810</p>	<p>PREMIUM</p>
<p>0506682</p>  <p>0186598 M=30x1,5 RHT</p>	<p>5010294502</p>	<p>T=52 L=847</p>	<p>PREMIUM</p>
<p>0506683</p>  <p>0186424 M=30x1,5 RHT</p>	<p>5010130393 74851</p>	<p>T=40 L=872</p>	<p>MIDLINER</p>
<p>0506684</p>  <p>0186598 M=30x1,5 RHT</p>	<p>5010294288</p>	<p>T=52 L=825</p>	<p>PREMIUM</p>
<p>0506685</p>  <p>0186598 M=30x1,5 RHT</p>	<p>5010294289 50106</p>	<p>T=62 L=861</p>	<p>PREMIUM</p>



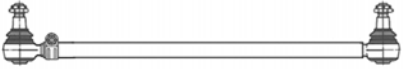

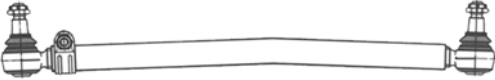







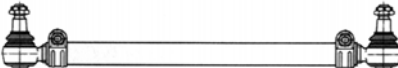

TIRANTI LONGITUDINALI - DRAG LINKS

RIF. OCAP OCAP REF.	RIF. ORIG O.E. NUMBER	NOTE REMARKS	MODELLO / DESCRIZIONE MODEL / DESCRIPTION
0506686   0186613 M=28x1,5 RHT	5010037418	T=40 L=902	MIDLINER
0506687   0186598 M=30x1,5 RHT	5010229242	T=52 L=934	KERAX
0506688   0186598 M=30x1,5 RHT	5010130344	T=52 L=737	MAGNUM
0506689   0187891 M=38x1,5 RHT	0023123262	L=505	BERLIET GHB 230-260 GLM 280-TLM 280
0506690   0186424 M=30x1,5 RHT	5000541230 50003	T=40 L=880	MIDLINER
0506691   0186598 M=30x1,5 RHT	5010239387 50101	L=1040	R: 310-330-340-350-365 370-380-390-420 MAJOR: 340-350-380-385-420











TIRANTI LONGITUDINALI - DRAG LINKS

RIF. OCAP OCAP REF.	RIF. ORIG O.E. NUMBER	NOTE REMARKS	MODELLO / DESCRIZIONE MODEL / DESCRIPTION
<p>0506693</p>  <p>0186424 M=30x1,5 RHT</p>	<p>5000932435 50101</p>	<p>L=985</p>	<p>MAGNUM AE MAGNUM E-TECH</p>
<p>0506751</p>  <p>0186598 M=30x1,5 RHT</p>	<p>5000785429</p>	<p>L=870</p>	<p>BERLIET GR-GC:231-291 GF:231-291-GRH PGC: 191-231 GRH 235</p>
<p>0507202</p>  <p>0186595 0196595 M=24x1,5 RHT M=24x1,5 LHT</p>	<p>5000395435 50003</p>	<p>L=495</p>	<p>B 70 - B 90 MESSENGER B 110.45-120</p>
<p>0507253</p>  <p>0186598 M=30x1,5 RHT</p>	<p>213123269 213123</p>	<p>L=807</p>	<p>BERLIET: GLT 190 - CBH 200</p>
<p>0507677</p>  <p>0186598 M=30x1,5 RHT</p>	<p>5001855163 0023123269 0023123268</p>	<p>L=850</p>	<p>GLR 190-230 GLC 190-230</p>
<p>0507854</p>  <p>0186598 M=30x1,5 RHT</p>	<p>5010294720</p>	<p>T=52 L=827</p>	<p>PREMIUM</p>



TIRANTI LONGITUDINALI - DRAG LINKS

RIF. OCAP OCAP REF.	RIF. ORIG O.E. NUMBER	NOTE REMARKS	MODELLO / DESCRIZIONE MODEL / DESCRIPTION
0507861   0182344 M=28x1,5 RHT	5010488164 50102	T=42 L=886	MIDLUM
0507863   0186424 M=30x1,5 RHT	5010488167 50103	T=42 L=946	MIDLUM
0507864   0182345 M=30x1,5 RHT 0192345 M=30x1,5 LHT 	7422482969 5010395796 5010566049	T=38 L=1500	MIDLUM
0507884   0186595 M=24x1,5 RHT 0196595 M=24x1,5 LHT 	5010488464	T=30 L=540	MASCOTT
0507988 	5010488097 50103	T=52 L=944	KERAX
0508721 	5001868374 5010630637 5010630638 7421560825	T=50 L=700	MAGNUM
0508722   0186598 M=30x1,5 RHT	5010383203 5010488836 5010557523	T=50 L=735	MAGNUM

TIRANTI LONGITUDINALI - DRAG LINKS

RIF. OCAP OCAP REF.	RIF. ORIG O.E. NUMBER	NOTE REMARKS	MODELLO / DESCRIZIONE MODEL / DESCRIPTION
0508723 	5010630822 5001868384 5010630823 7421560882	T=62 L=825	PREMIUM 2 SERIE C
0508998 	5010630980 7421021395 7482292079	T=60 L=552	PREMIUM 2 - KERAX
0509412 	5001868383 7421560865 5010630821 5010630820 7422163226	T=62 L=830	PREMIUM 2 SERIE C
0509439   0186598 M=30x1,5 RHT	5010557341 5010488759 5010488639 5010488084 20818854	T=50 L=900	MIDLUM
0509460 	5001868385 5010630812 5010630813 7421560892	T=62 L=833	SERIE C,D PREMIUM 2
0509462 	7422526504 74216	T=52 L=900	SERIE C,K,T
0509463   0186424 M=30x1,5 RHT	5010630255 50103	T=50 L=909	MIDLUM SERIE D
0509466   0188994 M=30x1,5 RHT	7422163231	T=62 L=825	SERIE C PREMIUM 2

TIRANTI LONGITUDINALI - DRAG LINKS

RIF. OCAP OCAP REF.	RIF. ORIG O.E. NUMBER	NOTE REMARKS	MODELLO / DESCRIZIONE MODEL / DESCRIPTION
0509467 	7421560848	T=52 L=696	MAGNUM
0509471 	7421560838	T=50 L=697	MAGNUM
0509475 	7422380814 74216	T=52 L=895	SERIE C - K - T

TESTE STERZO - TIE RODS END

RIF. OCAP OCAP REF.	RIF. ORIG O.E. NUMBER	NOTE REMARKS	MODELLO / DESCRIZIONE MODEL / DESCRIPTION
0182344 	-	L=110 M=28x1,5 RHT	MIDLUM
0186424 	5001832582 5001859985 5000295214 5000212483 5000812483 5001831473 5001850549	L=115 M=30x1,5 RHT	MIDLINER MIDLUM MAGNUM
0196424 	5000295215 5001859984 5001852263 5001834533 5001850550	L=115 M=30x1,5 LHT	MIDLINER MIDLUM
0186598 	5000288360 5001836298 5010832582 5000253852 5000590236 5000804824 5000858773 5001858760	L=120 M=30x1,5 RHT	MAGNUM MIDLINER PREMIUM KERAX
0196598 	5000288361 5001836297 5010832583 5000242478 5000823265 5000242486 5000858774 5001832581 5001858759	L=120 M=30x1,5 LHT	MAGNUM MIDLINER PREMIUM 2 KERAX
0186613 	5000823987	L=105 M=28x1,5 RHT	MIDLINER
0186758 	5000240688 5000242475 5000242479 5000242485	L=135 M=30x1,5 RHT	MAGNUM MIDLINER MIDLUM
0186595 	5001860770	L=95 M=24x1,5 RHT	MASCOTT

TESTE STERZO - TIE RODS END

RIF. OCAP OCAP REF.	RIF. ORIG O.E. NUMBER	NOTE REMARKS	MODELLO / DESCRIZIONE MODEL / DESCRIPTION
0196595 	5001860769	L=95 M=24X1,5 LHT	MASCOTT
0187723 	5001852452 5001858763 50 01 852 452 50 01 858 763	L=150 M=30x1,5 RHT	PREMIUM MIDLINER
0187891 	0023123262 *	L=130 M=38x1,5 RHT	BERLIET - GHB 230-260 - GLM 280-TLM 280
0187903 	5001867774 50018	L=120 M=32x1,5 RHT	MAGNUM PREMIUM - PREMIUM 2 KERAX
0188994 	7420937674	L=140 M=30x1,5 RHT	MAGNUM MIDLINER MIDLUM PREMIUM 2
0196599 	5001832579	L=120 M=38x1,5 LHT	MIDLINER
0286641 	5000288362	L=170 M=52x1,5 RHT	R R 340.17/.18/.24/.26 R R 350.17/.18/.24/.26 MAJOR R
0296641 	5000288363	L=170 M=52x1,5 LHT	R R 340.17/.18/.24/.26 R R 350.17/.18/.24/.26 MAJOR R

TESTE STERZO - TIE RODS END

RIF. OCAP OCAP REF.	RIF. ORIG O.E. NUMBER	NOTE REMARKS	MODELLO / DESCRIZIONE MODEL / DESCRIPTION
0287074 	-	L=138 M=38x1,5 RHT	
0297074 	-	L=138 M=38x1,5 LHT	
0287291 	7485114029 50007	L=95 M=24x1,5 RHT	MAGNUM PREMIUM
0287320 	5001823718	L=86 M=30x1,5 RHT	KERAX
0287350 	5000803460	L=167 M=52x1,5 RHT	G 170/210/230/260/290 GC 231/291 GF 151D TF 231D PGC 191/231
0297350 	5000803459	L=167 M=52x1,5 LHT	G 170/210/230/260/290 GC 231/291 GF 151D TF 231D PGC 191/231
0287360 	5001849880	L=90 M=26x1,5 RHT	PREMIUM
0287361 	5001849879	L=75 M=26x1,5 RHT	PREMIUM



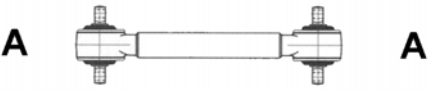
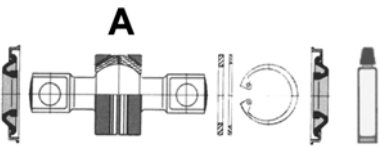
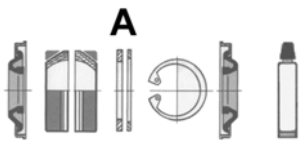
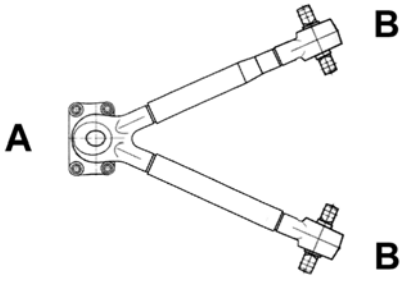
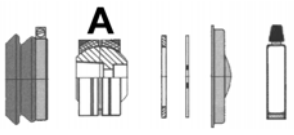
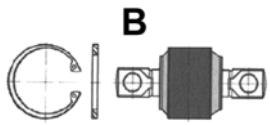

TESTE STERZO - TIE RODS END

RIF. OCAP OCAP REF.	RIF. ORIG O.E. NUMBER	NOTE REMARKS	MODELLO / DESCRIZIONE MODEL / DESCRIPTION
0287892 	5000288364	L=130 M=48x1,5 RHT	R R 340.16/.17/.18/.22/.24/.26 R R 350.17/.18/.24/.26 MAJOR R G G 260/290/320
0297892 	5000816456 50002	L=130 M=48x1,5 LHT	R R 340.16/.17/.18/.22/.24/.26 R R 350.17/.18/.24/.26 MAJOR R G G 260/290/320
0288930 	5001845430 50018	L=75 M=26x1,5 RHT	PREMIUM KERAX
0288993 	7403193731 31937	L=120 M=26x1,5 RHT	PREMIUM 2
0289456 	7421431678	L=120 M=26x1,5 RHT	SERIE C,D,T







BARRE DI REAZIONE - TORQUE RODS

RIF. OCAP OCAP REF.	RIF. ORIG O.E. NUMBER	NOTE REMARKS	MODELLO / DESCRIZIONE MODEL / DESCRIPTION
<p>0807252</p> 	<p>5010094941 5010094838 5001850530 5000750976 5000783574 5010064641</p>	<p>L=575 d=19</p>	<p>MAGNUM KERAX</p>
<p>0907252</p> 	<p>5001014345</p>	<p>I=145 D=65 d=19</p>	
<p>0907595</p> 	<p>5000819413 5001</p>	<p>I=145 p=30 d=19</p>	<p>senza perno (without pin)</p>
<p>0807762</p> 	<p>7420829503 74212</p>	<p>T=58 L=671 d=21</p>	<p>KERAX</p>
<p>0907762</p> 	<p>7420840820</p>	<p>D=80</p>	
<p>0907763</p> 	<p>7420840815</p>	<p>p=30 I=130 D=85 d=21/26</p>	

BARRE DI REAZIONE - TORQUE RODS

RIF. OCAP OCAP REF.	RIF. ORIG O.E. NUMBER	NOTE REMARKS	MODELLO / DESCRIZIONE MODEL / DESCRIPTION
<p>0807913</p> 	7420741703	L=668	PREMIUM 2 KERAX
<p>0907919</p> 	7420547286	p=24 l=130 D=75 d=19	
<p>0808738</p> 	7421051052	T=50 L=510	SERIE K KERAX
<p>0909994</p> 	7420702095	p=35 l=130 D=95 d=21	
<p>0809443</p> 	7420448089 20448	L=564 l=111/115 d=17/19	MIDLUM

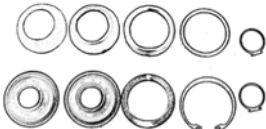
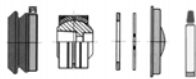
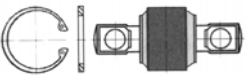





KIT DI SOSPENSIONE - SUSPENSION KITS

RIF. OCAP OCAP REF.	RIF. ORIG O.E. NUMBER	NOTE REMARKS	MODELLO / DESCRIZIONE MODEL / DESCRIPTION
0907252 	5001014345	l=145 D=65 d=19	MAGNUM KERAX
0907304 	5001842337	p=24 l=152 D1=85 d=21	KERAX
0907359 	7420702096	p=30 l=130 D=70 d=21	KERAX
0907528 	7485104224	p=24 l=115 D=75 d=17	PREMIUM KERAX MIDLUM
0907595 	5000819413 5001	l=145 p=30 d=19	MAGNUM KERAX
0907762 	7420840820	D=80	KERAX
0907763 	7420840815	p=30 l=130 D=85 d=21/26	KERAX
0907919 	7420547286	p=24 l=130 D=75 d=19	PREMIUM 2 KERAX



KIT DI SOSPENSIONE - SUSPENSION KITS

RIF. OCAP OCAP REF.	RIF. ORIG O.E. NUMBER	NOTE REMARKS	MODELLO / DESCRIZIONE MODEL / DESCRIPTION
0909994 	7420702095	p=35 l=130 D=95 d=21	SERIE K KERAX

STABILIZZATORI - STABILIZERS

RIF. OCAP OCAP REF.	RIF. ORIG O.E. NUMBER	NOTE REMARKS	MODELLO / DESCRIZIONE MODEL / DESCRIPTION
0507123 	7422325247 74214	T=30 L=325	SERIE C,K,T
0509374 	7420800194	T=30 L=275	KERAX
0509433 	7420850454	T=30 L=300	KERAX
0587990 	5000450713	T=28 L=335	MIDLINER - MIDLUM
0597990 	5000450714	T=28 L=335	MIDLINER - MIDLUM
0587991 	5010253256	T=28 L=280	MIDLINER - MIDLUM
0597991 	5010253255 50102	T=28 L=280	MIDLINER - MIDLUM

TESTE COMANDO CAMBIO - GEAR BOX CONTROL BALL JOINTS

RIF. OCAP OCAP REF.	RIF. ORIG O.E. NUMBER	NOTE REMARKS	MODELLO / DESCRIZIONE MODEL / DESCRIPTION
0187228 	5000807536	L=85 M=14x1,5 RHT	MIDLUM MIDLINER MAGNUM PREMIUM KERAX
0187346 	-	L=90 M=16x1,5 RHT	



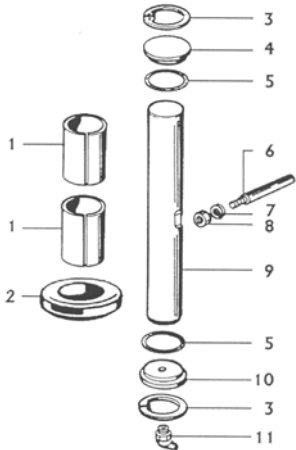
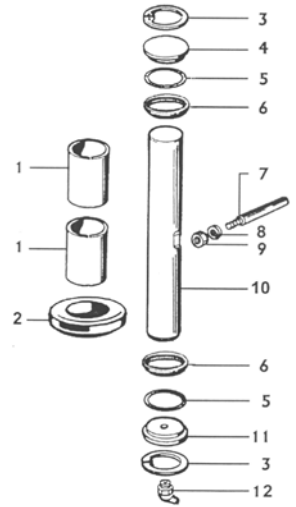



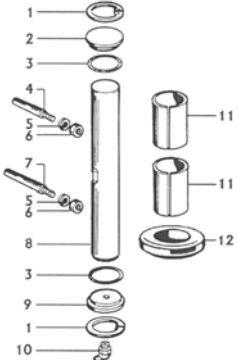
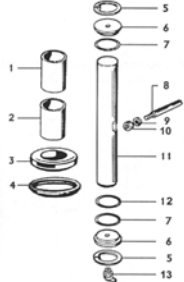
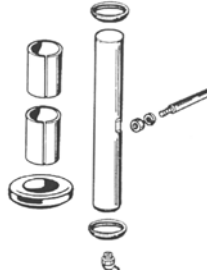
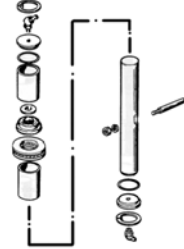

KIT PERNO FUSO - KING PIN SET

RIF. OCAP OCAP REF.	RIF. ORIG O.E. NUMBER	NOTE REMARKS	MODELLO / DESCRIZIONE MODEL / DESCRIPTION
<p>0927443</p> 	<p>5000794320 5005010016 (1) 5003090091 (2) 5003066054 (3) 5000737896 (4) 5000786411 (5) 5010056288 (6) 7703055013 (7) 5003032162 (8) 5000737903 (9) 5000737897 (10) 0851127900 (11)</p>	<p>L=280 D=46</p>	<p>C 260/C 290 ASSALE/AXLE: E6AC > 02/1987 E6A71 02/1986 > 02/1987 C 210/210.19 - CLR 220 ASSALE/AXLE: E6A4C > 02/1985 E6A711 01/1986 > CBH 280/340/350/380 ASSALE/AXLE: E6A511 > 02/1987 CLR 190/230 - GLC 190 ASSALE/AXLE: E6A411 02/1982 > 02/1985 GR 191/231 ASSALE/AXLE: E6A411 > 02/1982 R 310/370/390/420 ASSALE/AXLE: E6A21</p>
<p>0927444</p> 	<p>5000793849 5000737796 (1) 5010056928 (2) 7703066036 (3) 5010056390 (4) - (5) 5010067401 (6) 5010056288 (7) - (8) - (9) 5000737903 (10) 5000737797 (11) - (12)</p>	<p>L=280 D=46</p>	<p>C 260/C 290 ASSALE/AXLE: E6AC 03/1987 > E6A71 03/1987 > E6A4D 03/1984 > C 210/ 210.19 - CLR 220 ASSALE/AXLE: E6A40 >03/1987 E6A711 02/1986 > CLM 320/385 - CBH320/385 ASSALE/AXLE: E6A511 - E6B811 CBH 280/340/350/380 ASSALE/AXLE: E6A511 03/1987 > 09/1991 E6A811 03/1987 > 10/1991 E6B811 10/1991 > R310/330/340/365/RI375 A</p>

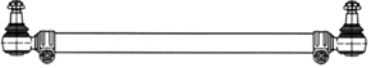

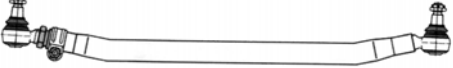



KIT PERNO FUSO - KING PIN SET

RIF. OCAP OCAP REF.	RIF. ORIG O.E. NUMBER	NOTE REMARKS	MODELLO / DESCRIZIONE MODEL / DESCRIPTION
0927445 	5000794319 - (1) 5000761303 (2) - (3) 0022225011 (4) - (5) - (6) - (7) 5000737530 (8) 5010056114 (9) - (10) 0000189901 (11) 5010056925 (12)	L=235 D=40	GLR 190/230 - GLC 190 ASSALE/AXLE: E5A421 12/1979 > G 260/G 290 ASSALE/AXLE: E5A4C CON TAMBURO FRENO 16 " WITH BRAKE CYL. 16" E5A4C 02/1985 > 02/1986 E5AC > 03/1987 E5A821 02/1985 > 02/1986 E5A4D > 03/1986 E5A921 09/1984 > 03/1987 PR 100.2/E 100.2 ASSALE/AXLE: TRAIN R 16 A MAXTER
0907263 	5000336305	L=178 D=35	JE 13/15 JP 11/13 JR 19/21 JX 19/21 M / S 4x4 ME 160/180/210 SE 160/180/210 CE 160/180/210 PS 150/160 S 130/150 TI / 170 (VF6JP) S 170 (FAB=SH)
0927447 	5000794318	L=300 D=46	GR 191/232/305/350 GBH 260/280 GLR 190/230 TBH 280 - TLM 280 TR 305/350 GLM 280 G 45 R 310 PX 30
0907264 	5000793641	L=153 D=28	JK 55/60/65/75 M / S 150/180/210/220/230 TI/250 MIDLINER G.B. S 100/120/135 S 110/130 (VF6JK) S 135/150 (MOT. 040226) S 140/160













BARRE ACCOPPIAMENTO - TIE RODS

RIF. OCAP OCAP REF.	RIF. ORIG O.E. NUMBER	NOTE REMARKS	MODELLO / DESCRIZIONE MODEL / DESCRIPTION
0506937   0186598 M=30x1,5 RHT	1409918 1897335 1737683 1723895 1501030 1385251	T=50 L=1740	SERIE 4 SERIE P,G,R,T
0506939   0186598 M=30x1,5 RHT 0196598 M=30x1,5 LHT 	2146104 1723896 1737684 1897336 2125091 2161884	T=40 L=1736	SERIE 4 SERIE P,G,R,T
0507723   0187723 M=30x1,5 RHT	1395614 2040254 1897333 1734019 1361413 2146105	T=62 L=1743	SERIE 4 SERIE P,G,R,T
0508758   0187894 M=30x1,5 RHT	2146104 1723896 1737684 1897336 2125091 2161884	T=52 L=1743	SERIE P,G,R,T



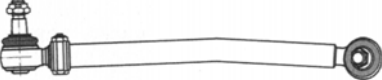

TIRANTI LONGITUDINALI - DRAG LINKS

RIF. OCAP OCAP REF.	RIF. ORIG O.E. NUMBER	NOTE REMARKS	MODELLO / DESCRIZIONE MODEL / DESCRIPTION
<p>0506816</p>  <p>0186598 M=30x1,5 RHT</p>	<p>278665 278666 0278665</p>	<p>L=947</p>	<p>82-92 112-142 93-113-143</p>
<p>0506829</p>  <p>0186598 M=30x1,5 RHT</p>	<p>352637</p>	<p>T=48 L=947</p>	<p>SERIE 3</p>
<p>0506846</p>  <p>0186598 M=30x1,5 RHT</p>	<p>291396 291395</p>	<p>L=728</p>	<p>SERIE 1: 141-143</p>
<p>0506869</p>  <p>0186598 M=30x1,5 RHT</p>	<p>1304571</p>	<p>T=50 L=915</p>	<p>SERIE 3</p>
<p>0506888</p>  <p>0186598 M=30x1,5 RHT</p>	<p>345124</p>	<p>T=50 L=927</p>	<p>SERIE 3</p>
<p>0506889</p>  <p>0186598 M=30x1,5 RHT</p>	<p>352635 278663 278664</p>	<p>L=947</p>	<p>SERIE 3: 93-113-143</p>

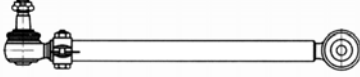

TIRANTI LONGITUDINALI - DRAG LINKS

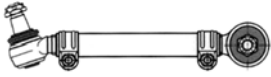
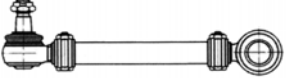
RIF. OCAP OCAP REF.	RIF. ORIG O.E. NUMBER	NOTE REMARKS	MODELLO / DESCRIZIONE MODEL / DESCRIPTION
0506913   0186598 M=30x1,5 RHT	390784	T=42 L=855	SERIE 3
0506914   0186598 M=30x1,5 RHT	291398	L=761	SERIE 2: 112
0506916   0186598 M=30x1,5 RHT	1308643	T=40 L=1590	SERIE 3
0506918   0186598 M=30x1,5 RHT	306981	T=48 L=947	SERIE 3
0506919   0186598 M=30x1,5 RHT	1369919	T=50 L=912	SERIE 3
0506920   0186598 M=30x1,5 RHT	1379071 1912757 1847311 1768898 1356055 1384025	T=52 L=1060	SERIE 4 SERIE P,G,R,T

TIRANTI LONGITUDINALI - DRAG LINKS

RIF. OCAP OCAP REF.	RIF. ORIG O.E. NUMBER	NOTE REMARKS	MODELLO / DESCRIZIONE MODEL / DESCRIPTION
<p>0506936</p>  <p>0186598 M=30x1,5 RHT</p>	1112511	T=50 L=843	SERIE 3
<p>0507188</p>  <p>0186598 M=30x1,5 RHT</p>	382774	T=40 L=578	SERIE 3
<p>0507731</p>  <p>0186598 M=30x1,4 RHT</p>	1847312 1769597 1384027 1379072	T=52 L=1060	SERIE 4 SERIE P,G,R,T
<p>0507766</p>  <p>0187723 M=30x1,5 RHT 0196598 M=30x1,5 LHT</p>	1343283 1759691	T=38 L=435	SERIE 4 SERIE P,G,R,T
<p>0507767</p>  <p>0186598 M=30x1,5 RHT 0196598 M=30x1,5 LHT</p>	1343266 175969	T=40 L=495	SERIE 4 SERIE P,G,R,T
<p>0507999</p> 	1343262 1869413	T=42 L=608	SERIE 4 - SERIE P,G,R,T
<p>0509416</p> 	1393383 178852	T=62 L=1950	SERIE 4 SERIE P,G,R,T

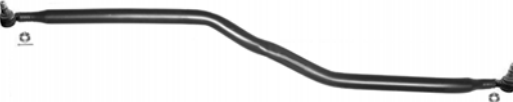



TIRANTI LONGITUDINALI - DRAG LINKS

RIF. OCAP OCAP REF.	RIF. ORIG O.E. NUMBER	NOTE REMARKS	MODELLO / DESCRIZIONE MODEL / DESCRIPTION
<p>0509477</p>  <p>0186598 M=30x1,5 RHT</p>	<p>2636650</p>	<p>T=52 L=1052</p>	<p>SERIE 4 SERIE P,G,R,T</p>
<p>0509879</p> 	<p>1343264 1732635 2007278</p>	<p>T=60 L=1921</p>	<p>SERIE 4 SERIE P,G,R,T</p>
<p>0509881</p>  <p>0186598 M=30x1,5 RHT</p>	<p>1348269 2007275</p>	<p>T=52 L=1062</p>	<p>SERIE 4 SERIE P,G,R,T</p>









TESTE STERZO - TIE RODS END

RIF. OCAP OCAP REF.	RIF. ORIG O.E. NUMBER	NOTE REMARKS	MODELLO / DESCRIZIONE MODEL / DESCRIPTION
0186598 	283784 468286 395010 1738381 0395010 1767328	L=120 M=30x1,5 RHT	SERIE 3
0196598 	283783 395009 468285 1358792 1738380	L=120 M=30x1,5 LHT	SERIE 3
0186758 	1337367 352645 352646	L=135 M=30x1,5 RHT	SERIE 4 SERIE P,G,R,T
0196758 	352645 1337366	L=135 M=30x1,5 LHT	SERIE 3
0187894 	1723897 2051041 2154938 2154939	L=145 M=30x1,5 RHT	SERIE P,G,R,T
0188994 	1358793	L=140 M=30x1,5 RHT	SERIE 4 SERIE P,G,R,T
0286759 	310980 031098	L=168 M=52x1,5 RHT	93-113-143 Sospensioni pneumatiche anteriori (Pneumatic suspension front)
0296759 	310979 0310979	L=168 M=52x1,5 LHT	93-113-143 Sospensioni pneumatiche anteriori (Pneumatic suspension front)

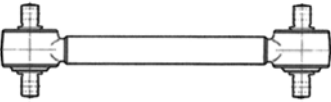



TESTE STERZO - TIE RODS END

RIF. OCAP OCAP REF.	RIF. ORIG O.E. NUMBER	NOTE REMARKS	MODELLO / DESCRIZIONE MODEL / DESCRIPTION
0287360 	1394444	L=90 M=26x1,5 RHT	SERIE 4 SERIE P,G,R,T
0287361 	1394443	L=75 M=26x1,5 RHT	SERIE 4 SERIE P,G,R,T
0287684 	1912759	L=95 M=26x1,5 RHT	SERIE 4 SERIE P,G,R,T
0289455 	1394447	L=115 M=26x1,5 RHT	SERIE 4 SERIE P,G,R,T

BARRE DI REAZIONE - TORQUE RODS

RIF. OCAP OCAP REF.	RIF. ORIG O.E. NUMBER	NOTE REMARKS	MODELLO / DESCRIZIONE MODEL / DESCRIPTION
<p>0807454</p>  <p>A A</p> <p>0907528</p>  <p>A</p>	<p>1428349 1326775</p> <p>639370 550808 1517403 1102506 1104334 550806</p>	<p>T=46 L=522 I=115</p> <p>p=24 I=115 D=75 d=17</p>	<p>SERIE 4 SERIE P,G,R,T</p>
<p>0807771</p>  <p>A A</p> <p>0907528</p>  <p>A</p>	<p>1428347 139918</p> <p>639370 550808 1517403 1102506 1104334 550806</p>	<p>L=568</p> <p>d=17</p> <p>p=24 I=115 D=75 d=17</p>	<p>SERIE 4 SERIE P,G,R,T</p>
<p>0808776</p>  <p>A A</p> <p>0907591</p>  <p>A</p>	<p>1101843 1379423 1393298 1942075</p> <p>550800 1628671 0003302111</p>	<p>T=48 L=752</p> <p>p=24 I=115 D=67 d=17</p>	<p>SERIE 4 SERIE P,G,R,T</p>
<p>0809434</p>  <p>B B</p> <p>0909434</p>  <p>B</p>	<p>1722582 1440028</p> <p>1444472</p>	<p>T=46 L=613,2</p> <p>p=24 I=115 D=70 d=19</p>	<p>SERIE P,G,R,T</p>



KIT DI SOSPENSIONE - SUSPENSION KITS

RIF. OCAP OCAP REF.	RIF. ORIG O.E. NUMBER	NOTE REMARKS	MODELLO / DESCRIZIONE MODEL / DESCRIPTION
0907259 	638862 639287 1104335 1953248 1435944	p=30 l=130 D=70 d=19	SERIE 4 SERIE P,G,R,T
0907405 	81432206202	l=100 D=67 d=17	4 114
0907528 	639370 550808 1517403 1102506 1104334 550806	p=24 l=115 D=75 d=17	SERIE 4 SERIE P,G,R,T
0907591 	550800 1628671 0003302111	p=24 l=115 D=67 d=17	SERIE 4 SERIE P,G,R,T
0909434 	1444472	p=24 l=115 D=70 d=19	SERIE P,G,R,T

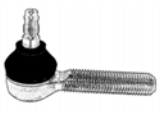









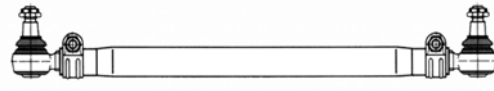

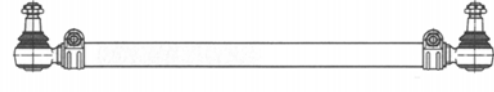
TESTE COMANDO CAMBIO - GEAR BOX CONTROL BALL JOINTS

RIF. OCAP OCAP REF.	RIF. ORIG O.E. NUMBER	NOTE REMARKS	MODELLO / DESCRIZIONE MODEL / DESCRIPTION
0187230 	350270 243664 0350270	L=82 M=14x2 RHT	SERIE 2: 112-142 SERIE 3: 93-113-143
0187231 	1383405	L=82 M=16x2 RHT	124-142-143-144











KIT PERNO FUSO - KING PIN SET

RIF. OCAP OCAP REF.	RIF. ORIG O.E. NUMBER	NOTE REMARKS	MODELLO / DESCRIZIONE MODEL / DESCRIPTION
0927452 	550732 550713 550714	L=228 D=53,5/44,5	ASSALE/AXLE: AM 60 - 291311 L-LB 81 1975 > G-P-T 82 1980 > LB-LBS 85 1973 > L-LS86 1975 > LB-LBS 86 1975 > LB-LBS 110 1968 > LB-LBS 111 1971 > L-LS-LT 111 1980> G-P-R 112 1980 > L-LS-LB-LBS 140 1971 > L-LS-LT-LB-LBS 141 1971 > T-R 142 1980> LT 146
0927453 	550730 550729	L=215 D=44,5/55	ASSALE/AXLE: AM 56 - AM 61 G 93 1986 > P 93 1986 > R 93 1986 > P 113 1986 > R 113 1986 > R 143 1986 > T 143 1986 >
0927454 	550257	L=223 D=55	ASSALE/AXLE: AM 800/820 113 P/R ASSALE/AXLE: 620/920 AMA 860 114 G ASSALE/AXLE: AM/AMA 740 AMA 860 > CH. 9014419 SAN - 4359879 SNL 1219062 SSS - AMD 740 - AMA 860 D 124 C/G/L ASSALE/AXLE: AM620/920 AMA 860 144 G ASSALE/AXLE: AM 740 - AM A 860 144 L

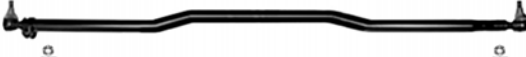



BARRE ACCOPPIAMENTO - TIE RODS

RIF. OCAP OCAP REF.	RIF. ORIG O.E. NUMBER	NOTE REMARKS	MODELLO / DESCRIZIONE MODEL / DESCRIPTION
0507109   0186959 M=30x1,5 RHT 0196959 M=30x1,5 LHT 	1626494 6862225 1606274 1611864 1505855	T=42 L=1592	FL 7 - 10 -12
0507124   0186959 M=30x1,5 RHT 0196959 M=30x1,5 LHT 	3962343 3988711 3986450 1626637	T=42 L=1640	FM 12 FH 12 - 16 FMX
0508736 	21560957 2537288	T=60 L=1655	FE - FE II
0509357   0187686 M=30x1,5 RHT	20392778 2126029	T=50 L=1645	FM 9
0509358   0189896 M=30x1,5 RHT	21260275 3198234	T=62 L=1660	FH 12-16 FMX II
0509359 	20587731 21106938 22159753	T=60 L=1660	FH 12-16 - FMX II
0509436 	22159757	T=52 L=1818	FH 12-FH 16-FM 12





BARRE ACCOPPIAMENTO - TIE RODS

RIF. OCAP OCAP REF.	RIF. ORIG O.E. NUMBER	NOTE REMARKS	MODELLO / DESCRIZIONE MODEL / DESCRIPTION
0509437 	22159765 2136701	T=48 L=1818	FH 16 FMX II
0509468 	21261985 2215976	T=60 L=1671	FH 16 FMX II
0509472   0187686 M=30x1,5 RHT	22159758	T=48 L=1025	FH 12-16 FM 9-12 FMX-FMX II
0509473 	22159755 2119277	T=60 L=1693	FH 16 FMX II
0509894   0187686 M=30x1,5 RHT	20399543 21299034 85115631	T=52 L=1818	FM 9 -12 FH 12 - 16
0509896   0189896 M=30x1,5 RHT	20393097 21260286 1612254 3985570	T=58 L=1640	FM 7 -10 - 12 FH 12-16
0509911   0187723 M=30x1,5 RHT	21560963 2082457	T=60 L=1686	FE - FE II



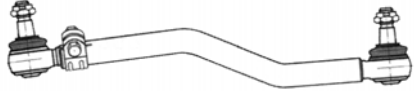

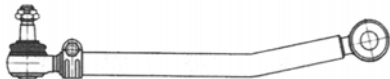

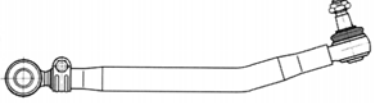



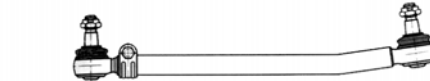

BARRE ACCOPPIAMENTO - TIE RODS

RIF. OCAP OCAP REF.	RIF. ORIG O.E. NUMBER	NOTE REMARKS	MODELLO / DESCRIZIONE MODEL / DESCRIPTION
0509914   0189914 M=30x1,5 RHT 0199914 M=30x1,5 LHT 	20581086	T=42 L=1669	FM 9 - 12 FH 12 - 16 FMX - FMX II
0509916   0189896 M=30x1,5 RHT	21260274 3198276	T=50 L=1634	FM 9 - 12 FH 12-16 FMX - FMX 2





TIRANTI LONGITUDINALI - DRAG LINKS

RIF. OCAP OCAP REF.	RIF. ORIG O.E. NUMBER	NOTE REMARKS	MODELLO / DESCRIZIONE MODEL / DESCRIPTION
<p>0506965</p>  <p>0186960 M=30x1,5 RHT</p>	<p>1626493 1588263 1606277 1584620</p>	<p>T=40 L=740</p>	<p>F 10/12/16 - FL 7/12 N 7/10 - NL 10/12</p>
<p>0506966</p>  <p>0186960 M=30x1,5 RHT</p>	<p>1588017 1626492 1505857 1577080</p>	<p>L=745</p>	<p>N 7-10-12 NL 10-12</p>
<p>0506967</p>  <p>0186960 M=30x1,5 RHT</p>	<p>1626751 1610338</p>	<p>T=42 L=850</p>	<p>F10 - F12 - F16</p>
<p>0506968</p>  <p>0186960 M=30x1,5 RHT</p>	<p>1613562 1626749</p>	<p>L=880</p>	<p>F 10-F 12-F 16 Sospensione anteriore Pneumatica (Pneumatic suspension front)</p>
<p>0507100</p>  <p>0186960 M=30x1,5 RHT</p>	<p>1592940</p>	<p>T=50 L=823</p>	<p>FL 7 - 10 - 12</p>
<p>0507101</p>  <p>0186960 M=30x1,5 RHT</p>	<p>1592939 85114144</p>	<p>T=50 L=823</p>	<p>FL 7 - 10 - 12</p>







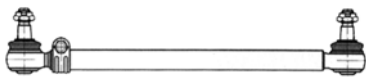





TIRANTI LONGITUDINALI - DRAG LINKS

RIF. OCAP OCAP REF.	RIF. ORIG O.E. NUMBER	NOTE REMARKS	MODELLO / DESCRIZIONE MODEL / DESCRIPTION
0507103   0186960 M=30x1,5 RHT	1606282 1587489 1576816	L=940	F 7 (4x2-6x2-6x4) F 10- F 12
0507104   0186960 M=30x1,5 RHT	1626750 1610074	L=850	F 10 -F 12 -F 16
0507105   0186960 M=30x1,5 RHT	1080788 1608954	L=835	F 12
0507106   0186960 M=30x1,5 RHT	1080787 1608953	L=860	F 12
0507107   0186946 M=30x1,5 RHT	1075005	T=50 L=863	FH 12 - 16
0507108   0186946 M=30x1,5 RHT	1691660	T=52 L=863	FH 12 - 16











TIRANTI LONGITUDINALI - DRAG LINKS

RIF. OCAP OCAP REF.	RIF. ORIG O.E. NUMBER	NOTE REMARKS	MODELLO / DESCRIZIONE MODEL / DESCRIPTION
<p>0507111</p>  <p>0186959 M=30x1,5 RHT</p>	<p>1075663 20393069 3988704</p>	<p>T=52 L=861</p>	<p>FM 7 - 10 - 12 FH 12 - 16</p>
<p>0507112</p>  <p>0186959 M=30x1,5 RHT</p>	<p>1075153 20393061 3988695 3988697</p>	<p>T=52 L=881</p>	<p>FM 7 - 10 - 12 FH 12 - 16</p>
<p>0507113</p>  <p>0186959 M=30x1,5 RHT</p>	<p>1628636 851142</p>	<p>T=52 L=881</p>	<p>FH 12 - 16</p>
<p>0507114</p>  <p>0186960 M=30x1,5 RHT</p>	<p>1080786 1592959</p>	<p>L=856</p>	<p>F 12-FL 7-FL 10- FL 12</p>
<p>0507115</p>  <p>0186424 M=30X1,5 RHT</p>	<p>6790572 67905729 20400941</p>	<p>L=871</p>	<p>FL 6</p>
<p>0507116</p>  <p>0186612 M=24x1,5 RHT</p>	<p>3124480 20400909 31244809 3124594 6777855 6791948</p>	<p>T=30 L=978</p>	<p>FL6</p>













TIRANTI LONGITUDINALI - DRAG LINKS

RIF. OCAP OCAP REF.	RIF. ORIG O.E. NUMBER	NOTE REMARKS	MODELLO / DESCRIZIONE MODEL / DESCRIPTION
0507117   0186424 M=30x1,5 RHT	1071169	L=821	FL 608-611
0507118   0186424 M=30x1,5 RHT	1071344 20400944 3127737	L=871	FL 6-FL 12
0507119   0186960 M=30x1,5 RHT	1094912	L=762	FL 10 (6x4)
0507120   0186946 M=30x1,5 RHT	1075664 3988701 20393063	T=52 L=861	FH 12 - 16 FM 12
0507121   0186948 M=30x1,5 RHT	6799189 67991893 3124962	L=893	FL 6
0507122   0186948 M=30x1,5 RHT	1071315	L=910	FL 6 FL 18

TIRANTI LONGITUDINALI - DRAG LINKS

RIF. OCAP OCAP REF.	RIF. ORIG O.E. NUMBER	NOTE REMARKS	MODELLO / DESCRIZIONE MODEL / DESCRIPTION
0507863   0186424 M=30x1,5 RHT	20709844 8216556	T=42 L=946	FL - FL II
0508723 	21560882 21560884 20727843	T=62 L=825	FE - FE II
0508799   0187686 M=30x1,5 RHT	20390745 2110693	T=50 L=885	FH - FH12 - FH16 FM 7 - FM 9 - FM 12
0509412 	20727840 21560865 21560868	T=62 L=830	FE - FE II
0509439   0186598 M=30x1,5 RHT	20818854	T=50 L=900	FL - FL III
0509441 	24425658 20393089 20442111 20513949	T=52 L=2111	FM 12
0509460 	20727850 21560892 21560894	T=62 L=833	FE-FE II







TIRANTI LONGITUDINALI - DRAG LINKS

RIF. OCAP OCAP REF.	RIF. ORIG O.E. NUMBER	NOTE REMARKS	MODELLO / DESCRIZIONE MODEL / DESCRIPTION
0509462 	22526504 23341677 21698607 21543888	T=52 L=900	FH 16 FMX II
0509463   0186424 M=30x1,5 RHT	20818840	T=50 L=909	FL - FL II - FL III
0509465   0187686 M=30x1,5 RHT	22159741	T=46 L=563	FH 12 FMX
0509466   0188994 M=30x1,5 RHT	22163223	T=62 L=825	FE - FE II
0509475 	22380814 225265	T=52 L=895	FH16 - FMX II
0509893   0186960 M=30x1,5 RHT	1094219 20453027	T=60 L=813	FL 10 - FL 12
0509895   0187686 M=30x1,5 RHT	20393187 21106952 20375556 21406952	T=52 L=863	FH - FH 12 - FH 16 - FM - FM 7 - FM 9 - FM 10 - FM 12

TIRANTI LONGITUDINALI - DRAG LINKS

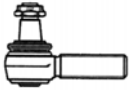
RIF. OCAP OCAP REF.	RIF. ORIG O.E. NUMBER	NOTE REMARKS	MODELLO / DESCRIZIONE MODEL / DESCRIPTION
<p>0509897</p>  <p>0186959 M=30x1,5 RHT</p>	<p>20393186 21106930 20375555 3986452</p>	<p>T=52 L=863</p>	<p>FM 7 - 10 - 12 FH 12 - 16 FMX - FMX II</p>







TESTE STERZO - TIE RODS END

RIF. OCAP OCAP REF.	RIF. ORIG O.E. NUMBER	NOTE REMARKS	MODELLO / DESCRIZIONE MODEL / DESCRIPTION
0186598 	20821160 20742127 20745043 20862494	L=125 M=30x1,5 RHT	FL FM 9 - 12
0186612 	1696919	L=105 M=24x1,5 RHT	FL6
0186758 	20862494 20742127 20745043 20821160	L=135 M=30x1,5 RHT	FE II FL II
0186946 	3090727 3110002 3988965 3090472	L=115 M=30x1,5 RHT	FL 10 FM 7 - FM 12
0186948 	1698047 1697246 1506269	L=120 M=30x1,5 RHT	F 4-F 6-F 7-F 10-F 12-F 16 FE 615 FL 4-FL 6- FL 7-FL 10-FL 12 FS 7
0186959 	1698846 3988965 1507823 3092472 1505759 6884002 6889479 85112073 85125126	L=120 M=30x1,5 RHT	FH 12 - 16 FM 10 - 12 FL 12
0196959 	1698847 1507822 1698533 3092471 1505758 3110001 3988968 6884001 6889478	L=120 M=30x1,5 LHT	FH 12 - 16 FM 10 - 12 FL 12

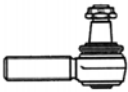
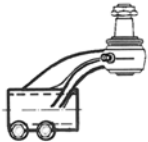





TESTE STERZO - TIE RODS END

RIF. OCAP OCAP REF.	RIF. ORIG O.E. NUMBER	NOTE REMARKS	MODELLO / DESCRIZIONE MODEL / DESCRIPTION
0186960 	1507826	L=120 M=30x1,5 RHT	FL 7 - 10 - 12
0196960 	1131744	L=120 M=30x1,5 LHT	FL 7 - 10 - 12
0187686 	3093647	L=140 M=30x1,5 RHT	FH 12 - 16 FM 9 - 10 - 12 FMX I - II
0187723 	20894438 2158039	L=150 M=30x1,5 RHT	FE
0188994 	20937674	L=140 M=30x1,5 RHT	FE FL I - II
0189896 	3097228 3099529 21263974 3092189	L=145 M=30x1,5 RHT	FH 12 - 16 FL 12 FM 9 - 10 - 12 FMX I - II
0189914 	20581089	L=136 M=30x1,5 RHT	FH 12 - 16 FM 9 - 12 FMX I - II
0199914 	20710008	L=136 M=30x1,5 LHT	FH 12 - 16 FM 9 - 12 FMX I - II

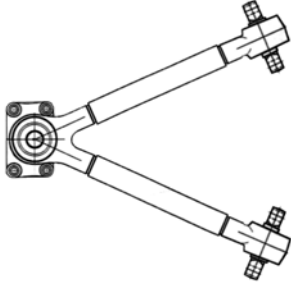
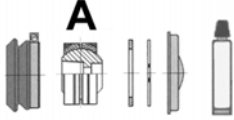

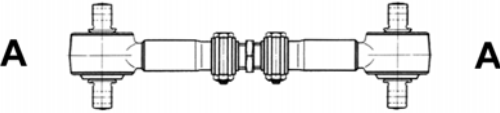

TESTE STERZO - TIE RODS END

RIF. OCAP OCAP REF.	RIF. ORIG O.E. NUMBER	NOTE REMARKS	MODELLO / DESCRIZIONE MODEL / DESCRIPTION
0196946 	3090728	L=115 M=30x1,5 LHT	FL 10 FM 7 - FM 12
0286964 	1699401 1696901 1131742 6889484	L=168 M=52x1,5 RHT	FL 12 FH 12 - 16
0296964 	1699400 1131741 6889483	L=168 M=52x1,5 LHT	FL 12 FH 12 - 16 FM 10 - 12
0288779 	20374698	L=88 M=26x1,5 RHT	FH 12 - 16 FM 12 FMX
0288993 	3193731 74031937	L=120 M=26x1,5 RHT	FH 12 - 16 - FM 9 - 12 - FMX
0289456 	21431678	L=120 M=26x1,5 RHT	FE II - FMX II
0289923 	3099128 3090291	L=90 M=36x1,5 RHT	FH 12 - 16 FL 12



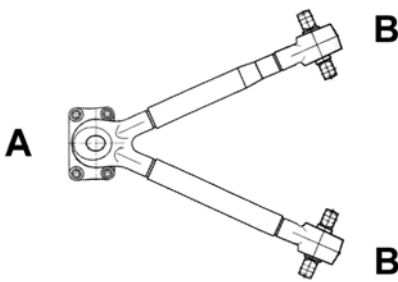
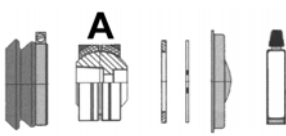
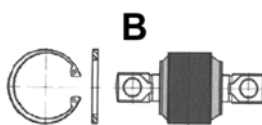



BARRE DI REAZIONE - TORQUE RODS

RIF. OCAP OCAP REF.	RIF. ORIG O.E. NUMBER	NOTE REMARKS	MODELLO / DESCRIZIONE MODEL / DESCRIPTION
<p>0807221</p> 	<p>1080690 1576952 1606200</p>	<p>L=635 d=23</p>	<p>FL 10 - 12</p>
<p>0907683</p> 	<p>273706</p>	<p>D=80 IK=46</p>	
<p>0807222</p> 	<p>1082104 1605035</p>	<p>T=48 L=666</p>	<p>FM 7 - 10 - 12 FH 12 - 16</p>
<p>0907222</p> 	<p>1598588</p>	<p>p=20 l=125 D=91 d=14</p>	
<p>0907224</p> 	<p>1135080</p>	<p>D=91 d=52</p>	
<p>0807687</p> 	<p>8158207 1607079 1581527</p>	<p>L=660 d=21</p>	<p>FL 10 - 12</p>
<p>0907359</p> 	<p>274019 273373 20702096</p>	<p>p=30 l=130 D=70 d=21</p>	





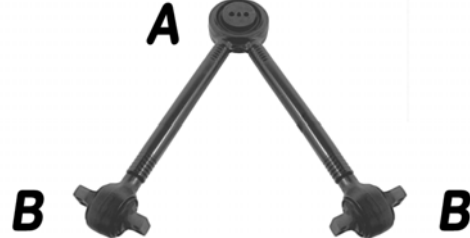

BARRE DI REAZIONE - TORQUE RODS

RIF. OCAP OCAP REF.	RIF. ORIG O.E. NUMBER	NOTE REMARKS	MODELLO / DESCRIZIONE MODEL / DESCRIPTION
0807762 	21295227 20829503 21474441 20392649 1626896 1629734 1076639	L=671 d=21	FH 12 - 16 FM 12 FMX - FMX II
0907762 	3090712	D=80	
0907763 	20840815 21295230 3093630 3093631	l=130 D=70 d=21	
0807913 	20507262 20367004 20741695 20741703	T=48 L=662	FM 9 - 10 - 12 FH 12 - 16 FE
0907919 	20547286	p=24 l=130 D=75 d=19	
0808738 	21051052 2052293	L=510	FH 12 - 16 FM 9 - 12 FM - FMX II
0909994 	20702095 273612	p=35 l=130 D=95 d=21	

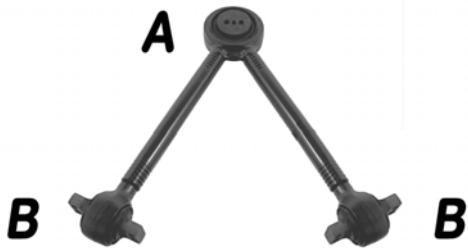



BARRE DI REAZIONE - TORQUE RODS

RIF. OCAP OCAP REF.	RIF. ORIG O.E. NUMBER	NOTE REMARKS	MODELLO / DESCRIZIONE MODEL / DESCRIPTION
<p>0809378</p>  <p>A A</p>	<p>20410053 2110615</p>	<p>T=48 L=799</p>	<p>FH 12 - 16 FM 9 - 12</p>
<p>0907528</p>  <p>A</p>	<p>85104224 3093462 271187</p>	<p>p=24 l=115 D=75 d=17</p>	
<p>0809381</p>  <p>B B</p>	<p>20491771 20556608 20703338</p>	<p>T=48 L=662</p>	<p>FH 12 - 16 FM 12 FMX - FMX II</p>
<p>0909909</p>  <p>B</p>	<p>3090452 3092452</p>	<p>p=24 l=115 D=75 d=17/20</p>	
<p>0809385</p>  <p>A B B</p>	<p>20556491 3173292</p>	<p>T=48 L=677</p>	<p>FM 7 - FM12 - FH 12-FH 16</p>
<p>0909379</p>  <p>A</p>	<p>1075255 20554908 3173759 1591689</p>	<p>l=21 D=138 d=14-16</p>	
<p>0909380</p>  <p>B</p>	<p>1628107</p>	<p>p=26 l=145 D=91 d=15</p>	



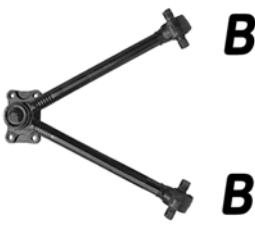





BARRE DI REAZIONE - TORQUE RODS

RIF. OCAP OCAP REF.	RIF. ORIG O.E. NUMBER	NOTE REMARKS	MODELLO / DESCRIZIONE MODEL / DESCRIPTION
0809386 	20556490 3173291 8156991 1628133	T=48 L=677	FH 12 - 16 FM 7 - 12
0909379 	1075255 20554908 3173759 1591689	I=21 D=138 d=14-16	
0909380 	1628107	p=26 I=145 D=91 d=15	
0809443 	20448089 7420448	L=564 I=111/115 d=17/19	FL - FL III
0809445 	21196798	L=625 I=115 d=17	FH 16 FMX II
0809907 	3172829	T=48 L=677	FL 12 FH 12-16 FM 7 -9- 12
0907529 	274056 276192	p=35 I=152 D=95 d=23	

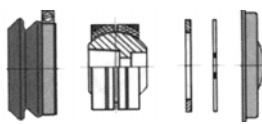

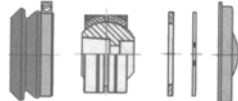



BARRE DI REAZIONE - TORQUE RODS

RIF. OCAP OCAP REF.	RIF. ORIG O.E. NUMBER	NOTE REMARKS	MODELLO / DESCRIZIONE MODEL / DESCRIPTION
<p>0809909</p> 	<p>20382314 20502944 1094466</p>	<p>T=48 L=649 I=115 d=17/20</p>	<p>FL 12 FM 10 - 12</p>
<p>0909909</p> 	<p>3090452 3092452</p>	<p>p=24 I=115 D=75 d=17/20</p>	
<p>0809917</p> 	<p>20374444 20517494 20410530 20509018</p>	<p>L=625</p>	<p>FH 12 - 16 FM 9 - 12 FMX - FMX II</p>
<p>0907528</p> 	<p>85104224 3093462 271187</p>	<p>p=24 I=115 D=75 d=17</p>	

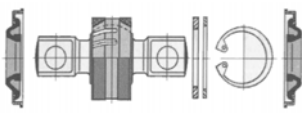
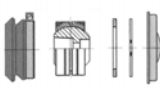
KIT DI SOSPENSIONE - SUSPENSION KITS

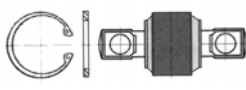
RIF. OCAP OCAP REF.	RIF. ORIG O.E. NUMBER	NOTE REMARKS	MODELLO / DESCRIZIONE MODEL / DESCRIPTION
0907222 	1598588	p=20 l=125 D=91 d=14	FM 7 - 10 -12 FH 12 - 16
0907224 	1135080	D=91 d=52	FM 7 - 10 -12 FH 12 - 16
0907257 	271188	IK=38 T=50 D=65	FH 12 - 16 FL 12 FM 10 - 12
0907296 	274070	p=24 l=130 D=75 d=21	FL 12
0907297 	3093469	IK=38 D=65	FH 16
0907304 	274068	p=24 l=152 D1=85 d=21	FL 12
0907359 	274019 273373 20702096	p=30 l=130 D=70 d=21	FL 12
0907528 	85104224 3093462 271187	p=24 l=115 D=75 d=17	FM 9 - 12 FH 12 - 16 FMX - FMX II

KIT DI SOSPENSIONE - SUSPENSION KITS

RIF. OCAP OCAP REF.	RIF. ORIG O.E. NUMBER	NOTE REMARKS	MODELLO / DESCRIZIONE MODEL / DESCRIPTION
0907529 	274056 276192	p=35 l=152 D=95 d=23	FH 16 FL 12
0907534 	273375 6885513	p=35 l=152 D=80 d=23	FL 12
0907683 	273706	D=80 lK=46	FL 12
0907762 	3090712	D=80	FH 12 - 16 FM 12 FMX - FMX II
0907763 	20840815 21295230 3093630 3093631	l=130 D=70 d=21	FH 12 - 16 FM 12 FMX - FMX II
0907919 	20547286	p=24 l=130 D=75 d=19	FM 9 - 10 - 12 FH 12 - 16 FE
0909379 	1075255 20554908 3173759 1591689	l=21 D=138 d=14-16	FH 12 - 16 FM 7- 12
0909380 	1628107	p=26 l=145 D=91 d=15	FH 12 - 16 FM 7- 12
0909909 	3090452 3092452	p=24 l=115 D=75 d=17/20	FH 12 - 16 FM 9 - 10 - 12 FMX - FMX II





KIT DI SOSPENSIONE - SUSPENSION KITS

RIF. OCAP OCAP REF.	RIF. ORIG O.E. NUMBER	NOTE REMARKS	MODELLO / DESCRIZIONE MODEL / DESCRIPTION
0909994 	20702095 273612	p=35 l=130 D=95 d=21	FH 12 - 16 FM 9 - 12 FM - FMX II

STABILIZZATORI - STABILIZERS

RIF. OCAP OCAP REF.	RIF. ORIG O.E. NUMBER	NOTE REMARKS	MODELLO / DESCRIZIONE MODEL / DESCRIPTION
0507123 	22325247 21446333 3986433	T=30 L=325	FH 12 - 16 FM 12 FMX - FMX II
0507221 	20443062 2099441	T=36 L=380	FH 12 - 16 FM 9 - 12 FMX
0507918 	20443061 20444418 20443065	T=36 L=435	FH 12 - 16 FM 9 - 12 FMX
0508786 	20477807 3944046	T=30 L=340	FH 12 - 16 FM 9 - 12 FMX - FMX II
0508787 	20443063 20994420 3173615 20443067	T=36 L=350	FH 12 - 16 FM 12 FMX
0509449 	21119067 21119056 21287062 21119053	T=36 L=390	FH 12 - 16 FMX - FMX II
0509450 	22318841 211976	T=38 L=373	FH 16 FMX II
0509451 	21176251 21146255 21176253 21176255 21182239 21146253 21182238 21287063	T=36 L=350	FH 12 - 16 FM 12 FMX - FMX II

STABILIZZATORI - STABILIZERS

RIF. OCAP OCAP REF.	RIF. ORIG O.E. NUMBER	NOTE REMARKS	MODELLO / DESCRIZIONE MODEL / DESCRIPTION
0509452 	22318844 212097	T=38 L=443	FH 16 FMX - FMX II
0509453 	3987356	T=36 L=350	FM 12
0509905 	3987354 3173613	T=36 L=435	FM 12 FH 12
0509915 	21287061 2111906	T=36 L=435	FM FH 12 - 16 FMX - FMX II

TESTE COMANDO CAMBIO - GEAR BOX CONTROL BALL JOINTS

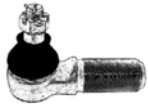
RIF. OCAP OCAP REF.	RIF. ORIG O.E. NUMBER	NOTE REMARKS	MODELLO / DESCRIZIONE MODEL / DESCRIPTION
<p>0187241</p> 	<p>1527234 1668638 382745</p>	<p>L=90 M=28x1,5 RHT</p>	<p>F 7-F 10-F12-F 16 FL 6-FL 7-FL 10-FL 12 N 7-N 10-N 12</p>

KIT PERNO FUSO - KING PIN SET

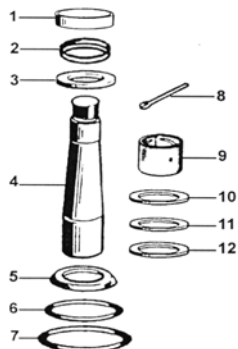
RIF. OCAP OCAP REF.	RIF. ORIG O.E. NUMBER	NOTE REMARKS	MODELLO / DESCRIZIONE MODEL / DESCRIPTION
<p>0927458</p> 	<p>3090266 271142 270912 276023 276031</p>	<p>L=251 D=50/38</p>	<p>ASSALE/AXLE: 253290 F7 - F S 7 - F10 - F12 - F16 FH 12 - FH 16 - FL7 - FL10 - FL12 FM7 - FM12 - N7 - N10 NL10 - NL12</p>

RIF. ORIG O.E. NUMBER	RIF. OCAP REF. OCAP	MARCA	PAG.	RIF. ORIG O.E. NUMBER	RIF. OCAP REF. OCAP	MARCA	PAG.
0001146170	0506026	RENAULT V.I.	8-1	0013308835	0196424	MERCEDES	6-12
0003220323	0508968	MERCEDES	6-22	0014600448	0186551	MERCEDES	6-12
0003220623	0508968	MERCEDES	6-22	0014600548	0196961	MERCEDES	6-14
00032207	0508969	MERCEDES	6-22	0014600705	0507968	MERCEDES	6-10
0003301235	0186612	MERCEDES	6-13	0014600805	0507968	MERCEDES	6-10
0003301335	0196612	MERCEDES	6-13	0014601105	0507961	MERCEDES	6-9
0003301411	0907635	MERCEDES	6-16	0014601305	0507911	MERCEDES	6-9
0003301435	0186613	MERCEDES	6-13	0014601405	0507911	MERCEDES	6-9
0003301535	0186613	MERCEDES	6-13	0014601448	0196598	MERCEDES	6-12
0003302111	0907591	SCANIA	9-8	0014601505	0507587	MERCEDES	6-1
0003307135	0186613	MERCEDES	6-13	0014601748	0186551	MERCEDES	6-12
0003307335	0186424	MERCEDES	6-12	0014601848	0186598	MERCEDES	6-12
0003307535	0196612	MERCEDES	6-13	0014602248	0186598	MERCEDES	6-12
0003307635	0196612	MERCEDES	6-13	0014602348	0196598	MERCEDES	6-12
0003309335	0186613	MERCEDES	6-13	0014602548	0196961	MERCEDES	6-14
0003309535	0186613	MERCEDES	6-13	0014602948	0187916	MERCEDES	6-14
0003309735	0186612	MERCEDES	6-13	0014603	0506582	MERCEDES	6-5
0003309935	0186612	MERCEDES	6-13	0014603148	0186424	MERCEDES	6-12
0003382129	0186613	MERCEDES	6-13	0014603648	0196598	MERCEDES	6-12
0003383429	0186612	MERCEDES	6-13	0014603848	0187959	MERCEDES	6-14
0003502205	0907609	MERCEDES	6-18	0014604148	0187789	MERCEDES	6-14
0003502305	0907634	MERCEDES	6-15	0014604448	0186424	MERCEDES	6-12
0003502405	0907774	IVECO	4-27	0014604848	0187959	MERCEDES	6-14
0003502505	0907599	MERCEDES	6-15	0014605148	0187959	MERCEDES	6-14
0003502705	0907547	MERCEDES	6-16	0014606705	0506585	MERCEDES	6-5
0003503105	0908991	MERCEDES	6-21	0014607005	0507968	MERCEDES	6-10
0003503205	0907609	MERCEDES	6-18	0014607305	0507587	MERCEDES	6-1
0003503605	0907908	MERCEDES	6-17	0014607448	0197146	MERCEDES	6-13
0003503705	0907909	MERCEDES	6-17	0014607648	0186551	MERCEDES	6-12
0003504005	0907634	MERCEDES	6-15	0014607848	0196598	MERCEDES	6-12
0003504405	0907634	MERCEDES	6-15	0014607948	0196961	MERCEDES	6-14
0003504505	0907609	MERCEDES	6-18	0014608648	0187959	MERCEDES	6-14
00035046	0907622	MERCEDES	6-19	0014609805	0507632	MERCEDES	6-7
00035047	0907984	MERCEDES	6-21	0014609905	0507632	MERCEDES	6-7
00035049	0907774	MERCEDES	6-17	0014609948	0187959	MERCEDES	6-14
0004601048	0186598	MERCEDES	6-12	0023123247	0506642	RENAULT V.I.	8-5
0004601748	0187467	MERCEDES	6-13	0023123262	0506689	RENAULT V.I.	8-7
0004602648	0187146	MERCEDES	6-13	0023123262 *	0187891	RENAULT V.I.	8-13
0004602848	0186598	MERCEDES	6-12	0023123268	0507677	RENAULT V.I.	8-8
0004602948	0186598	MERCEDES	6-12	0023123269	0507677	RENAULT V.I.	8-8
0004603448	0196598	MERCEDES	6-12	0023301535	0186424	MERCEDES	6-12
0004603548	0196598	MERCEDES	6-12	00246	0288930	MERCEDES	6-14
0004604948	0287684	MERCEDES	6-14	0024600148	0186598	MERCEDES	6-12
0004605748	0186551	MERCEDES	6-12	0024600405	0507961	MERCEDES	6-9
0004606148	0196961	MERCEDES	6-14	0024600505	0507911	MERCEDES	6-9
0004606848	0186551	MERCEDES	6-12	0024604305	0507630	MERCEDES	6-7
0004606948	0196961	MERCEDES	6-14	0024604405	0507630	MERCEDES	6-7
0004607105	0506585	MERCEDES	6-5	0024604505	0507789	MERCEDES	6-8
0004607148	0196961	MERCEDES	6-14	0024604605	0507789	MERCEDES	6-8
0004607205	0506585	MERCEDES	6-5	0024604705	0507631	MERCEDES	6-7
0004607548	0186551	MERCEDES	6-12	0024604805	0507631	MERCEDES	6-7
0004609	0507967	MERCEDES	6-10	0024605	0507615	MERCEDES	6-6
00046098	0507627	MERCEDES	6-7	0024605205	0507912	MERCEDES	6-9
0005861035	0907533	MAN	5-9	0024605905	0507965	MERCEDES	6-9
00058612	0907330	MERCEDES	6-15	0024606005	0507965	MERCEDES	6-9
0013300135	0186424	MERCEDES	6-12	0024606105	0507962	MERCEDES	6-9
0013300235	0186424	MERCEDES	6-12	0024606405	0507632	MERCEDES	6-7
0013300335	0186547	MERCEDES	6-12	0024608	0508957	MERCEDES	6-10

RIF. ORIGINALE - RIF. OCAP - MARCA

CORRISPONDENZE RIFERIMENTI ORIGINALI

Cross Reference Guide - Vergleichenummern List - Liste D'equivalence - Guia De Intercambios

RIF. ORIG O.E. NUMBER	RIF. OCAP REF. OCAP	MARCA	PAG.	RIF. ORIG O.E. NUMBER	RIF. OCAP REF. OCAP	MARCA	PAG.
0024609605	0507614	MERCEDES	6-6	1094219	0509893	VOLVO	10-9
0024609705	0507614	MERCEDES	6-6	1094466	0809909	VOLVO	10-18
0034600705	0507963	MERCEDES	6-9	1094912	0507119	VOLVO	10-7
0034601805	0507642	MERCEDES	6-8	1101843	0808776	SCANIA	9-8
0034601905	0507642	MERCEDES	6-8	1102506	0907528	SCANIA	9-8
0034603105	0507961	MERCEDES	6-9	1104334	0907528	SCANIA	9-8
0034603205	0507911	MERCEDES	6-9	1104335	0907259	SCANIA	9-9
0034603305	0507587	MERCEDES	6-1	1112511	0506936	SCANIA	9-4
0034604105	0507965	MERCEDES	6-9	11200265-0	0506588	NISSAN	7-1
0034604205	0507962	MERCEDES	6-9	11200360-0	0186592	NISSAN	7-3
0034604605	0507887	MERCEDES	6-8	11200360-0A	0186592	NISSAN	7-3
0034604705	0507963	MERCEDES	6-9	11200360-0B	0186592	NISSAN	7-3
0034604805	0507630	MERCEDES	6-7	11200361-0	0196592	NISSAN	7-3
0034604905	0507631	MERCEDES	6-7	11200361-0A	0196592	NISSAN	7-3
0034605705	0507614	MERCEDES	6-6	11200361-0B	0196592	NISSAN	7-3
0034605805	0507642	MERCEDES	6-8	11200454-0	0506590	NISSAN	7-2
0034605905	0507827	MERCEDES	6-8	112004540	0506590	NISSAN	7-2
0034606205	0507962	MERCEDES	6-9	1131741	0296964	VOLVO	10-13
0034608605	0509470	MERCEDES	6-11	1131742	0286964	VOLVO	10-13
0110197	0186613	DAF	2-7	1131744	0196960	VOLVO	10-12
0117343	0506429	DAF	2-3	1135080	0907224	VOLVO	10-14
0171215	0506431	DAF	2-3	1146170	0506026	RENAULT V.I.	8-1
01902137	0807363	IVECO	4-26	1149875	0187723	DAF	2-7
0267743	0807501	DAF	2-10	1149907	0186598	DAF	2-7
0278665	0506816	SCANIA	9-2	11505036-0	0506591	NISSAN	7-2
0288281	0507934	DAF	2-1	1152350	0186598	DAF	2-7
0310979	0296759	SCANIA	9-6	1164684	0509912	RENAULT V.I.	8-3
031098	0286759	SCANIA	9-6	1228115	0196598	DAF	2-7
03304800A	0907533	MAN	5-9	1229944	0186424	DAF	2-7
0350270	0187230	SCANIA	9-10	1247956	0506435	DAF	2-4
0386930	0187228	DAF	2-15	1247957	0506434	DAF	2-3
0395010	0186598	SCANIA	9-6	1252284	0907296	DAF	2-13
042489573	0186758	IVECO	4-18	1257890	0186598	DAF	2-7
0554765	0506430	DAF	2-3	1261101	0807555	DAF	2-11
0649819	0807525	DAF	2-10	1270853	0507933	DAF	2-1
0689748	0907528	DAF	2-13	1270854	0507934	DAF	2-1
0691704	0907257	DAF	2-13	1271124	0907258	DAF	2-11
0691709	0907359	DAF	2-10	1283211	0506435	DAF	2-4
0693778	0907595	DAF	2-14	1283212	0506434	DAF	2-3
0696320	0907525	DAF	2-10	1286343	0506432	DAF	2-1
0696321	0907529	DAF	2-11	1291060	0506433	DAF	2-3
0698724	0907489	DAF	2-10	1294251	0807927	DAF	2-11
09316137	0907586	IVECO	4-30	1297572	0507942	DAF	2-1
094038	0506430	DAF	2-3	1304571	0506869	SCANIA	9-2
1071169	0507117	VOLVO	10-7	1308643	0506916	SCANIA	9-3
1071315	0507122	VOLVO	10-7	1315447	0196424	DAF	2-8
1071344	0507118	VOLVO	10-7	1319838	0196424	DAF	2-8
1075005	0507107	VOLVO	10-5	1321936	0907927	DAF	2-11
1075153	0507112	VOLVO	10-6	1326775	0807454	SCANIA	9-8
1075255	0909379	VOLVO	10-16	1326896	0186424	DAF	2-7
1075663	0507111	VOLVO	10-6	1329134	0196598	DAF	2-7
1075664	0507120	VOLVO	10-7	13306635	0196424	MERCEDES	6-12
1076639	0807762	VOLVO	10-15	1331925	0186424	DAF	2-7
1080690	0807221	VOLVO	10-14	1332123	0196424	DAF	2-8
1080786	0507114	VOLVO	10-6	1337366	0196758	SCANIA	9-6
1080787	0507106	VOLVO	10-5	1337367	0186758	SCANIA	9-6
1080788	0507105	VOLVO	10-5	1337644	0507934	DAF	2-1
1082104	0807222	VOLVO	10-14	1343262	0507999	SCANIA	9-4

RIF. ORIGINALE - RIF. OCAP - MARCA

CORRISPONDENZE RIFERIMENTI ORIGINALI

Cross Reference Guide - Vergleichenummern List - Liste D'equivalence - Guia De Intercambios

RIF. ORIG O.E. NUMBER	RIF. OCAP REF. OCAP	MARCA	PAG.	RIF. ORIG O.E. NUMBER	RIF. OCAP REF. OCAP	MARCA	PAG.
1343264	0509879	SCANIA	9-5	1435944	0907259	SCANIA	9-9
1343266	0507767	SCANIA	9-4	1440028	0809434	SCANIA	9-8
1343283	0507766	SCANIA	9-4	1444472	0909434	SCANIA	9-8
1348269	0509881	SCANIA	9-5	1448063	0507948	DAF	2-4
1351714	0506435	DAF	2-4	1448064	0509464	DAF	2-5
1351734	0506433	DAF	2-3	1451118	0507937	DAF	2-4
1353391	0507933	DAF	2-1	1451122	0507936	DAF	2-4
1356055	0506920	SCANIA	9-3	1451129	0507938	DAF	2-4
1358792	0196598	SCANIA	9-6	14601148	0186551	MERCEDES	6-12
1358793	0188994	SCANIA	9-6	14601648	0288930	MERCEDES	6-14
1361155	0507942	DAF	2-1	14602448	0186551	MERCEDES	6-12
1361413	0507723	SCANIA	9-1	14602905	0506582	MERCEDES	6-5
1361649	0807501	DAF	2-10	14603448	0186424	MERCEDES	6-12
1361650	0807501	DAF	2-10	14604348	0196424	MERCEDES	6-12
1361651	0807489	DAF	2-10	14607105	0507967	MERCEDES	6-10
1361652	0807930	DAF	2-11	14607748	0186598	MERCEDES	6-12
1363859	0507948	DAF	2-4	14608348	0186424	MERCEDES	6-12
1368270	0807489	DAF	2-10	14608448	0186424	MERCEDES	6-12
1369919	0506919	SCANIA	9-3	1501030	0506937	SCANIA	9-1
1373135	0186613	DAF	2-7	1505758	0196959	VOLVO	10-11
1373137	0196613	DAF	2-7	1505759	0186959	VOLVO	10-11
1373878	0509464	DAF	2-5	1505855	0507109	VOLVO	10-1
1376730	0907297	DAF	2-13	1505857	0506966	VOLVO	10-4
1379071	0506920	SCANIA	9-3	1506269	0186948	VOLVO	10-11
1379072	0507731	SCANIA	9-4	1507822	0196959	VOLVO	10-11
1379423	0808776	SCANIA	9-8	1507823	0186959	VOLVO	10-11
1380417	0507938	DAF	2-4	1507826	0186960	VOLVO	10-12
1383405	0187231	SCANIA	9-10	1517403	0907528	SCANIA	9-8
1384025	0506920	SCANIA	9-3	1527234	0187241	VOLVO	10-24
1384027	0507731	SCANIA	9-4	15540921	0927387	IVECO	4-39
1385251	0506937	SCANIA	9-1	1576816	0507103	VOLVO	10-5
1385492	0506434	DAF	2-3	1576952	0807221	VOLVO	10-14
1385497	0506435	DAF	2-4	1577080	0506966	VOLVO	10-4
1385499	0506433	DAF	2-3	1581527	0807687	VOLVO	10-14
1390932	0807489	DAF	2-10	1584620	0506965	VOLVO	10-4
139264	0507936	DAF	2-4	1587489	0507103	VOLVO	10-5
1393298	0808776	SCANIA	9-8	1588017	0506966	VOLVO	10-4
1393383	0509416	SCANIA	9-4	1588263	0506965	VOLVO	10-4
1394443	0287361	SCANIA	9-7	1591689	0909379	VOLVO	10-16
1394444	0287360	SCANIA	9-7	1592939	0507101	VOLVO	10-4
1394447	0289455	SCANIA	9-7	1592940	0507100	VOLVO	10-4
1395614	0507723	SCANIA	9-1	1592959	0507114	VOLVO	10-6
1395993	0509946	DAF	2-6	1598588	0907222	VOLVO	10-14
1395994	0507947	DAF	2-4	1602821	0507948	DAF	2-4
1395995	0509947	DAF	2-6	1603789	0186598	DAF	2-7
1398368	0907257	DAF	2-13	1603883	0187723	DAF	2-7
139918	0807771	SCANIA	9-8	1604247	0196168	DAF	2-8
1399724	0287503	DAF	2-9	1604248	0186168	DAF	2-7
1401937	0509941	DAF	2-5	1605035	0807222	VOLVO	10-14
1401942	0197928	DAF	2-8	1606200	0807221	VOLVO	10-14
1403898	0509943	DAF	2-5	1606274	0507109	VOLVO	10-1
1405309	0509943	DAF	2-5	1606277	0506965	VOLVO	10-4
14066	0509939	DAF	2-5	1606282	0507103	VOLVO	10-5
1407963	0506168	DAF	2-1	1607079	0807687	VOLVO	10-14
1409918	0506937	SCANIA	9-1	1608953	0507106	VOLVO	10-5
1426101	0509474	DAF	2-5	1608954	0507105	VOLVO	10-5
1428347	0807771	SCANIA	9-8	1610074	0507104	VOLVO	10-5
1428349	0807454	SCANIA	9-8	1610338	0506967	VOLVO	10-4

RIF. ORIGINALE - RIF. OCAP - MARCA

CORRISPONDENZE RIFERIMENTI ORIGINALI

Cross Reference Guide - Vergleichenummern List - Liste D'equivalence - Guia De Intercambios

RIF. ORIG O.E. NUMBER	RIF. OCAP REF. OCAP	MARCA	PAG.	RIF. ORIG O.E. NUMBER	RIF. OCAP REF. OCAP	MARCA	PAG.
1611088	0196598	DAF	2-7	1769597	0507731	SCANIA	9-4
1611864	0507109	VOLVO	10-1	178852	0509416	SCANIA	9-4
1612254	0509896	VOLVO	10-2	1793875	0807489	DAF	2-10
1613562	0506968	VOLVO	10-4	1793876	0807930	DAF	2-11
1618048	0186598	DAF	2-7	1793877	0807525	DAF	2-10
1620436	0807930	DAF	2-11	1807596	0509469	DAF	2-2
1620437	0807525	DAF	2-10	1817809	0807501	DAF	2-10
1626492	0506966	VOLVO	10-4	1828523	0509459	DAF	2-5
1626493	0506965	VOLVO	10-4	1847311	0506920	SCANIA	9-3
1626494	0507109	VOLVO	10-1	1847312	0507731	SCANIA	9-4
1626637	0507124	VOLVO	10-1	1869413	0507999	SCANIA	9-4
1626749	0506968	VOLVO	10-4	1897333	0507723	SCANIA	9-1
1626750	0507104	VOLVO	10-5	1897335	0506937	SCANIA	9-1
1626751	0506967	VOLVO	10-4	1897336	0506939	SCANIA	9-1
1626896	0807762	VOLVO	10-15	1902296	0196168	DAF	2-8
1628107	0909380	VOLVO	10-16	1902942	0509459	DAF	2-5
1628133	0809386	VOLVO	10-17	1902997	0186168	DAF	2-7
1628636	0507113	VOLVO	10-6	1903652	0280515	IVECO	4-18
1628671	0907591	SCANIA	9-8	1912757	0506920	SCANIA	9-3
1629734	0807762	VOLVO	10-15	1912759	0287684	SCANIA	9-7
1656428	0807501	DAF	2-10	1942075	0808776	SCANIA	9-8
1663207	0807501	DAF	2-10	1953248	0907259	SCANIA	9-9
1668638	0187241	VOLVO	10-24	2007275	0509881	SCANIA	9-5
1685552	0188994	DAF	2-8	2007278	0509879	SCANIA	9-5
1689605	0196608	DAF	2-8	20367004	0807913	VOLVO	10-15
1691660	0507108	VOLVO	10-5	20374444	0809917	VOLVO	10-18
1696901	0286964	VOLVO	10-13	20374698	0288779	VOLVO	10-13
1696919	0186612	VOLVO	10-11	20375555	0509897	VOLVO	10-10
1697246	0186948	VOLVO	10-11	20375556	0509895	VOLVO	10-9
1698047	0186948	VOLVO	10-11	20382314	0809909	VOLVO	10-18
1698533	0196959	VOLVO	10-11	20390745	0508799	VOLVO	10-8
1698846	0186959	VOLVO	10-11	20392649	0807762	VOLVO	10-15
1698847	0196959	VOLVO	10-11	20392778	0509357	VOLVO	10-1
1699400	0296964	VOLVO	10-13	20393061	0507112	VOLVO	10-6
1699401	0286964	VOLVO	10-13	20393063	0507120	VOLVO	10-7
1700000	0507949	DAF	2-2	20393069	0507111	VOLVO	10-6
1700913	0509939	DAF	2-5	20393089	0509441	VOLVO	10-8
1703472	0186168	DAF	2-7	20393097	0509896	VOLVO	10-2
1703473	0196168	DAF	2-8	20393186	0509897	VOLVO	10-10
1705907	0186168	DAF	2-7	20393187	0509895	VOLVO	10-9
1705908	0196168	DAF	2-8	20399543	0509894	VOLVO	10-2
1722582	0809434	SCANIA	9-8	20400909	0507116	VOLVO	10-6
1723895	0506937	SCANIA	9-1	20400941	0507115	VOLVO	10-6
1723896	0506939	SCANIA	9-1	20400944	0507118	VOLVO	10-7
1723897	0187894	SCANIA	9-6	2040254	0507723	SCANIA	9-1
1732635	0509879	SCANIA	9-5	20410053	0809378	VOLVO	10-16
1732973	0509438	DAF	2-2	20410530	0809917	VOLVO	10-18
1734019	0507723	SCANIA	9-1	20442111	0509441	VOLVO	10-8
1737683	0506937	SCANIA	9-1	20443061	0507918	VOLVO	10-22
1737684	0506939	SCANIA	9-1	20443062	0507221	VOLVO	10-22
1738380	0196598	SCANIA	9-6	20443063	0508787	VOLVO	10-22
1738381	0186598	SCANIA	9-6	20443065	0507918	VOLVO	10-22
1743554	0186613	DAF	2-7	20443067	0508787	VOLVO	10-22
1743594	0196613	DAF	2-7	20444418	0507918	VOLVO	10-22
175969	0507767	SCANIA	9-4	20448	0809443	RENAULT V.I.	8-17
1759691	0507766	SCANIA	9-4	20448089	0809443	VOLVO	10-17
1767328	0186598	SCANIA	9-6	20453027	0509893	VOLVO	10-9
1768898	0506920	SCANIA	9-3	20477807	0508786	VOLVO	10-22

RIF. ORIGINALE - RIF. OCAP - MARCA

CORRISPONDENZE RIFERIMENTI ORIGINALI

Cross Reference Guide - Vergleichenummern List - Liste D'equivalence - Guia De Intercambios

RIF. ORIG O.E. NUMBER	RIF. OCAP REF. OCAP	MARCA	PAG.	RIF. ORIG O.E. NUMBER	RIF. OCAP REF. OCAP	MARCA	PAG.
20491771	0809381	VOLVO	10-16	21196798	0809445	VOLVO	10-17
20502944	0809909	VOLVO	10-18	211976	0509450	VOLVO	10-22
20507262	0807913	VOLVO	10-15	212097	0509452	VOLVO	10-23
20509018	0809917	VOLVO	10-18	2125091	0506939	SCANIA	9-1
2051041	0187894	SCANIA	9-6	21260274	0509916	VOLVO	10-3
20513949	0509441	VOLVO	10-8	21260275	0509358	VOLVO	10-1
20517494	0809917	VOLVO	10-18	21260286	0509896	VOLVO	10-2
2052293	0808738	VOLVO	10-15	2126029	0509357	VOLVO	10-1
20547286	0907919	VOLVO	10-15	21261985	0509468	VOLVO	10-2
20554908	0909379	VOLVO	10-16	21263974	0189896	VOLVO	10-12
20556490	0809386	VOLVO	10-17	21287061	0509915	VOLVO	10-23
20556491	0809385	VOLVO	10-16	21287062	0509449	VOLVO	10-22
20556608	0809381	VOLVO	10-16	21287063	0509451	VOLVO	10-22
20581086	0509914	VOLVO	10-3	21295227	0807762	VOLVO	10-15
20581089	0189914	VOLVO	10-12	21295230	0907763	VOLVO	10-15
20587731	0509359	VOLVO	10-1	21299034	0509894	VOLVO	10-2
20702095	0909994	VOLVO	10-15	213123	0507253	RENAULT V.I.	8-8
20702096	0907359	VOLVO	10-14	213123269	0507253	RENAULT V.I.	8-8
20703338	0809381	VOLVO	10-16	2136701	0509437	VOLVO	10-2
20709844	0507863	VOLVO	10-8	21406952	0509895	VOLVO	10-9
20710008	0199914	VOLVO	10-12	21431678	0289456	VOLVO	10-13
20727840	0509412	VOLVO	10-8	21446333	0507123	VOLVO	10-22
20727843	0508723	VOLVO	10-8	2146104	0506939	SCANIA	9-1
20727850	0509460	VOLVO	10-8	2146105	0507723	SCANIA	9-1
20741695	0807913	VOLVO	10-15	21474441	0807762	VOLVO	10-15
20741703	0807913	VOLVO	10-15	21543888	0509462	VOLVO	10-9
20742127	0186598	VOLVO	10-11	2154938	0187894	SCANIA	9-6
20745043	0186598	VOLVO	10-11	2154939	0187894	SCANIA	9-6
20818840	0509463	VOLVO	10-9	21560865	0509412	VOLVO	10-8
20818854	0509439	RENAULT V.I.	8-10	21560868	0509412	VOLVO	10-8
20818854	0509439	VOLVO	10-8	21560882	0508723	VOLVO	10-8
20821160	0186598	VOLVO	10-11	21560884	0508723	VOLVO	10-8
2082457	0509911	VOLVO	10-2	21560892	0509460	VOLVO	10-8
20829503	0807762	VOLVO	10-15	21560894	0509460	VOLVO	10-8
20840815	0907763	VOLVO	10-15	21560957	0508736	VOLVO	10-1
20862494	0186598	VOLVO	10-11	21560963	0509911	VOLVO	10-2
20894438	0187723	VOLVO	10-12	2158039	0187723	VOLVO	10-12
20937674	0188994	VOLVO	10-12	2161884	0506939	SCANIA	9-1
2099441	0507221	VOLVO	10-22	21698607	0509462	VOLVO	10-9
20994420	0508787	VOLVO	10-22	22159741	0509465	VOLVO	10-9
21051052	0808738	VOLVO	10-15	22159753	0509359	VOLVO	10-1
2110615	0809378	VOLVO	10-16	22159755	0509473	VOLVO	10-2
2110693	0508799	VOLVO	10-8	22159757	0509436	VOLVO	10-1
21106930	0509897	VOLVO	10-10	22159758	0509472	VOLVO	10-2
21106938	0509359	VOLVO	10-1	2215976	0509468	VOLVO	10-2
21106952	0509895	VOLVO	10-9	22159765	0509437	VOLVO	10-2
21119053	0509449	VOLVO	10-22	22163223	0509466	VOLVO	10-9
21119056	0509449	VOLVO	10-22	22318841	0509450	VOLVO	10-22
2111906	0509915	VOLVO	10-23	22318844	0509452	VOLVO	10-23
21119067	0509449	VOLVO	10-22	22325247	0507123	VOLVO	10-22
21146253	0509451	VOLVO	10-22	22380814	0509475	VOLVO	10-9
21146255	0509451	VOLVO	10-22	225265	0509475	VOLVO	10-9
21176251	0509451	VOLVO	10-22	22526504	0509462	VOLVO	10-9
21176253	0509451	VOLVO	10-22	23341677	0509462	VOLVO	10-9
21176255	0509451	VOLVO	10-22	243664	0187230	SCANIA	9-10
21182238	0509451	VOLVO	10-22	24425658	0509441	VOLVO	10-8
21182239	0509451	VOLVO	10-22	24604905	0507615	MERCEDES	6-6
2119277	0509473	VOLVO	10-2	2460515	0187157	IVECO	4-35

RIF. ORIGINALE - RIF. OCAP - MARCA

CORRISPONDENZE RIFERIMENTI ORIGINALI

Cross Reference Guide - Vergleichenummern List - Liste D'equivalence - Guia De Intercambios

RIF. ORIG O.E. NUMBER	RIF. OCAP REF. OCAP	MARCA	PAG.	RIF. ORIG O.E. NUMBER	RIF. OCAP REF. OCAP	MARCA	PAG.
24608605	0508957	MERCEDES	6-10	3092471	0196959	VOLVO	10-11
24608805	0509461	MERCEDES	6-10	3092472	0186959	VOLVO	10-11
2463583	0187156	IVECO	4-35	3093462	0907528	VOLVO	10-16
247605	0506788	IVECO	4-1	3093469	0907297	VOLVO	10-19
2537288	0508736	VOLVO	10-1	3093630	0907763	VOLVO	10-15
257890	0186598	DAF	2-7	3093631	0907763	VOLVO	10-15
2636650	0509477	SCANIA	9-5	3093647	0187686	VOLVO	10-12
270912	0927458	VOLVO	10-25	3097228	0189896	VOLVO	10-12
271142	0927458	VOLVO	10-25	3099128	0289923	VOLVO	10-13
271187	0907528	VOLVO	10-16	3099529	0189896	VOLVO	10-12
271188	0907257	VOLVO	10-19	310979	0296759	SCANIA	9-6
273203	0287503	DAF	2-9	310980	0286759	SCANIA	9-6
273373	0907359	VOLVO	10-14	3110001	0196959	VOLVO	10-11
273375	0907534	VOLVO	10-20	3110002	0186946	VOLVO	10-11
273612	0909994	VOLVO	10-15	311300	0196424	DAF	2-8
273706	0907683	VOLVO	10-14	3124480	0507116	VOLVO	10-6
274019	0907359	VOLVO	10-14	31244809	0507116	VOLVO	10-6
274056	0907529	VOLVO	10-17	3124594	0507116	VOLVO	10-6
274068	0907304	VOLVO	10-19	3124962	0507121	VOLVO	10-7
274070	0907296	VOLVO	10-19	3127737	0507118	VOLVO	10-7
276023	0927458	VOLVO	10-25	3172829	0809907	VOLVO	10-17
276031	0927458	VOLVO	10-25	3173291	0809386	VOLVO	10-17
276192	0907529	VOLVO	10-17	3173292	0809385	VOLVO	10-16
278663	0506889	SCANIA	9-2	3173613	0509905	VOLVO	10-23
278664	0506889	SCANIA	9-2	3173615	0508787	VOLVO	10-22
278665	0506816	SCANIA	9-2	3173759	0909379	VOLVO	10-16
278666	0506816	SCANIA	9-2	31937	0288993	RENAULT V.I.	8-15
283783	0196598	SCANIA	9-6	3193731	0288993	VOLVO	10-13
283784	0186598	SCANIA	9-6	3198234	0509358	VOLVO	10-1
288281	0507934	DAF	2-1	3198276	0509916	VOLVO	10-3
291395	0506846	SCANIA	9-2	3220423	0508969	MERCEDES	6-22
291396	0506846	SCANIA	9-2	3406218	0196424	MERCEDES	6-12
291398	0506914	SCANIA	9-3	345124	0506888	SCANIA	9-2
2966321	0186613	IVECO	4-16	3500413	0907330	MERCEDES	6-15
2966635	0186613	IVECO	4-16	3502005	0907984	MERCEDES	6-21
2966688	0186424	IVECO	4-15	3502105	0907622	MERCEDES	6-19
2966891	0186424	IVECO	4-15	3502405	0907774	MERCEDES	6-17
2969507	0196613	IVECO	4-17	350270	0187230	SCANIA	9-10
2980884	0907258	DAF	2-11	3503307135	0196424	MERCEDES	6-12
2980884	0907258	IVECO	4-23	352635	0506889	SCANIA	9-2
2983125	0907262	IVECO	4-24	352637	0506829	SCANIA	9-2
2984511	0196424	IVECO	4-15	352645	0186758	SCANIA	9-6
2992593	0602749	IVECO	4-22	352646	0186758	SCANIA	9-6
3023300035	0196424	MERCEDES	6-12	3753220423	0508968	MERCEDES	6-22
3023300135	0196424	MERCEDES	6-12	3754600005	0507887	MERCEDES	6-8
3023300235	0196424	MERCEDES	6-12	3754600405	0507789	MERCEDES	6-8
3023300335	0196424	MERCEDES	6-12	3754601505	0507911	MERCEDES	6-9
3023300355	0196424	MERCEDES	6-12	3754601605	0507587	MERCEDES	6-1
306981	0506918	SCANIA	9-3	382745	0187241	VOLVO	10-24
3090266	0927458	VOLVO	10-25	382774	0507188	SCANIA	9-4
3090291	0289923	VOLVO	10-13	3834600605	0506963	MERCEDES	6-6
3090452	0909909	VOLVO	10-16	3834600805	0506584	MERCEDES	6-5
3090472	0186946	VOLVO	10-11	3834601405	0506963	MERCEDES	6-6
3090712	0907762	VOLVO	10-15	3834601605	0506584	MERCEDES	6-5
3090727	0186946	VOLVO	10-11	3834602305	0506963	MERCEDES	6-6
3090728	0196946	VOLVO	10-13	3834602405	0506584	MERCEDES	6-5
3092189	0189896	VOLVO	10-12	3834604405	0506963	MERCEDES	6-6
3092452	0909909	VOLVO	10-16	3834604505	0506584	MERCEDES	6-5

RIF. ORIGINALE - RIF. OCAP - MARCA

CORRISPONDENZE RIFERIMENTI ORIGINALI

Cross Reference Guide - Vergleichenummern List - Liste D'equivalence - Guia De Intercambios

RIF. ORIG O.E. NUMBER	RIF. OCAP REF. OCAP	MARCA	PAG.	RIF. ORIG O.E. NUMBER	RIF. OCAP REF. OCAP	MARCA	PAG.
386930	0187228	DAF	2-15	41005523	0186949	IVECO	4-38
3874600005	0506579	MERCEDES	6-4	4100609	0507293	IVECO	4-12
3874600405	0506575	MERCEDES	6-4	41009661	0807358	IVECO	4-26
3874600605	0506580	MERCEDES	6-4	41009665	0807211	IVECO	4-23
3874600705	0506962	MERCEDES	6-5	41009961	0807225	IVECO	4-24
3874601405	0506962	MERCEDES	6-5	41011	0807579	IVECO	4-28
3874603205	0506962	MERCEDES	6-5	41011006	0807295	IVECO	4-25
3874603305	0506962	MERCEDES	6-5	41011470	0507287	IVECO	4-12
3874604405	0506580	MERCEDES	6-4	41016958	0506897	IVECO	4-9
3874604505	0506580	MERCEDES	6-4	41016961	0507287	IVECO	4-12
3874604805	0506579	MERCEDES	6-4	41016964	0506927	IVECO	4-9
3874604905	0506579	MERCEDES	6-4	41017269	0507287	IVECO	4-12
3874605005	0506575	MERCEDES	6-4	41017272	0506927	IVECO	4-9
3895860033	0927436	MERCEDES	6-23	4102826	0507904	IVECO	4-14
390784	0506913	SCANIA	9-3	41028598	0807211	IVECO	4-23
3913300019	0927436	MERCEDES	6-23	41028599	0807296	IVECO	4-25
3913300603	0507610	MERCEDES	6-2	410326	0507366	IVECO	4-3
3913300803	0507610	MERCEDES	6-2	41032826	0507207	IVECO	4-12
3913301003	0507610	MERCEDES	6-2	41033237	0507366	IVECO	4-3
3913301203	0507610	MERCEDES	6-2	41033731	0807226	IVECO	4-24
3915860033	0927436	MERCEDES	6-23	41034479	0807211	IVECO	4-23
3933200632	0506575	MERCEDES	6-4	41035951	0807358	IVECO	4-26
3944046	0508786	VOLVO	10-22	41036943	0506847	IVECO	4-1
395009	0196598	SCANIA	9-6	41036944	0506932	IVECO	4-2
395010	0186598	SCANIA	9-6	41042050	0807211	IVECO	4-23
3953500006	0807611	MERCEDES	6-15	41042092	0807296	IVECO	4-25
3962343	0507124	VOLVO	10-1	41042093	0807299	IVECO	4-25
3985570	0509896	VOLVO	10-2	41042730	0506932	IVECO	4-2
3986433	0507123	VOLVO	10-22	41042919	0506931	IVECO	4-9
3986450	0507124	VOLVO	10-1	41042938	0506847	IVECO	4-1
3986452	0509897	VOLVO	10-10	41203863	0281786	IVECO	4-38
3987354	0509905	VOLVO	10-23	41203864	0291786	IVECO	4-38
3987356	0509453	VOLVO	10-23	4121516	0507370	IVECO	4-13
3988695	0507112	VOLVO	10-6	41218021	0807363	IVECO	4-26
3988697	0507112	VOLVO	10-6	4121848	0181785	IVECO	4-38
3988701	0507120	VOLVO	10-7	4121862	0807372	IVECO	4-27
3988704	0507111	VOLVO	10-6	41218621	0807372	IVECO	4-27
3988711	0507124	VOLVO	10-1	41226580	0507370	IVECO	4-13
3988965	0186946	VOLVO	10-11	41272428	0809448	IVECO	4-28
3988968	0196959	VOLVO	10-11	41272429	0807358	IVECO	4-26
4018036	0186603	IVECO	4-15	412727	0807373	IVECO	4-27
4018037	0196603	IVECO	4-18	41272706	0807373	IVECO	4-27
4025438	0286665	IVECO	4-19	4129673	0807374	IVECO	4-27
4028250	0186604	IVECO	4-15	41296730	0807374	IVECO	4-27
4028251	0196604	IVECO	4-16	41298449	0507904	IVECO	4-14
4054600005	0507617	MERCEDES	6-7	4200048	0807262	IVECO	4-24
4054600305	0507617	MERCEDES	6-7	42001325	0506855	IVECO	4-8
4054600605	0507617	MERCEDES	6-7	42001326	0506855	IVECO	4-8
41002119	0291786	IVECO	4-38	42003432	0506847	IVECO	4-1
41002770	0807211	IVECO	4-23	42026853	0506788	IVECO	4-1
410032	0807292	IVECO	4-24	42034054	0807262	IVECO	4-24
41005450	0506932	IVECO	4-2	42037384	0506827	IVECO	4-1
41005451	0506932	IVECO	4-2	42037386	0506904	IVECO	4-2
41005463	0506931	IVECO	4-9	42037386	0506904	RENAULT V.I.	8-1
41005466	0506927	IVECO	4-9	42041107	0807579	IVECO	4-28
41005469	0507287	IVECO	4-12	42041328	0291786	IVECO	4-38
41005472	0506897	IVECO	4-9	42042912	0181785	IVECO	4-38
41005475	0507293	IVECO	4-12	42042950	0506848	IVECO	4-8

RIF. ORIGINALE - RIF. OCAP - MARCA

CORRISPONDENZE RIFERIMENTI ORIGINALI

Cross Reference Guide - Vergleichenummern List - Liste D'equivalence - Guia De Intercambios

RIF. ORIG O.E. NUMBER	RIF. OCAP REF. OCAP	MARCA	PAG.	RIF. ORIG O.E. NUMBER	RIF. OCAP REF. OCAP	MARCA	PAG.
42043293	0506856	IVECO	4-8	4523292	0196605	IVECO	4-16
420439	0506856	IVECO	4-8	4540023	0927387	IVECO	4-39
4204391	0506848	IVECO	4-8	4545422	0506987	IVECO	4-10
42064639	0506827	IVECO	4-1	4546822	0507154	IVECO	4-11
42065332	0807295	IVECO	4-25	4568702	0506977	IVECO	4-10
42079850	0291786	IVECO	4-38	4573092	0507154	IVECO	4-11
42079852	0291786	IVECO	4-38	4579231	0186614	IVECO	4-17
42086458	0506855	IVECO	4-8	4579232	0196614	IVECO	4-17
42087842	0506840	IVECO	4-8	4580778	0186684	IVECO	4-17
4211553	0507314	IVECO	4-12	4580782	0187152	IVECO	4-18
42117267	0506955	IVECO	4-9	4582159	0286652	IVECO	4-19
42118693	0506955	IVECO	4-9	4588688	0506976	IVECO	4-10
42118694	0507314	IVECO	4-12	4596193	0927383	IVECO	4-39
42118781	0506955	IVECO	4-9	4596822	0927383	IVECO	4-39
4244600305	0507611	MERCEDES	6-6	4596824	0927383	IVECO	4-39
42483386	0186598	IVECO	4-15	4607048	0186551	MERCEDES	6-12
42484886	0186613	IVECO	4-16	4608393	0927383	IVECO	4-39
42484887	0196613	IVECO	4-17	4609905	0507627	MERCEDES	6-7
42487165	0186612	IVECO	4-16	4613620	0927383	IVECO	4-39
42489395	0196598	IVECO	4-15	4624032	0506720	IVECO	4-5
42489574	0196598	IVECO	4-15	4624116	0506721	IVECO	4-5
4249343	0907330	IVECO	4-25	4626917	0506709	IVECO	4-4
42493781	0186424	IVECO	4-15	4663787	0186603	IVECO	4-15
42495718	0186424	IVECO	4-15	4663972	0186604	IVECO	4-15
42530316	0287320	IVECO	4-20	4663974	0196604	IVECO	4-16
4253044	0289923	IVECO	4-21	4664090	0287150	IVECO	4-19
42532977	0607552	IVECO	4-22	4664292	0186605	IVECO	4-16
42533073	0287361	IVECO	4-20	4664295	0196605	IVECO	4-16
42533101	0287360	IVECO	4-20	4664297	0186605	IVECO	4-16
42533102	0287906	IVECO	4-20	4664347	0296606	IVECO	4-19
42534911	0287552	IVECO	4-20	4664349	0286606	IVECO	4-18
42535046	0907304	IVECO	4-28	4664353	0286610	IVECO	4-19
42537936	0186758	IVECO	4-18	466446	0286650	IVECO	4-19
4253804	0287320	IVECO	4-20	4664462	0286652	IVECO	4-19
42538048	0289923	IVECO	4-21	4664586	0186657	IVECO	4-17
42538384	0188994	IVECO	4-18	4665005	0186649	IVECO	4-17
42551289	0787250	IVECO	4-33	4665007	0186648	IVECO	4-17
42551290	0797250	IVECO	4-33	4665009	0286647	IVECO	4-19
42551296	0797249	IVECO	4-33	4665085	0506709	IVECO	4-4
42551297	0787249	IVECO	4-32	4665209	0506710	IVECO	4-4
42556991	0287552	IVECO	4-20	4665422	0286658	IVECO	4-19
42569562	0289426	IVECO	4-20	4665501	0506711	IVECO	4-4
42569563	0289425	IVECO	4-20	4666933	0506723	IVECO	4-5
42569566	0609422	IVECO	4-22	4666954	0506720	IVECO	4-5
4274600005	0507611	MERCEDES	6-6	4666991	0506750	IVECO	4-7
4274600105	0507611	MERCEDES	6-6	4666993	0506723	IVECO	4-5
4274600305	0507611	MERCEDES	6-6	4667156	0506721	IVECO	4-5
4274600405	0507611	MERCEDES	6-6	4668206	0286658	IVECO	4-19
4510017	0286606	IVECO	4-18	4668258	0506971	IVECO	4-10
4510018	0296606	IVECO	4-19	4668402	0506984	IVECO	4-10
4510019	0186605	IVECO	4-16	4669091	0506712	IVECO	4-4
4510620	0186605	IVECO	4-16	4669094	0506753	IVECO	4-7
4514235	0286610	IVECO	4-19	4676168	0927365	IVECO	4-39
4514245	0286650	IVECO	4-19	4676170	0927365	IVECO	4-39
4520694	0506712	IVECO	4-4	468285	0196598	SCANIA	9-6
4520697	0186657	IVECO	4-17	468286	0186598	SCANIA	9-6
4520698	0506753	IVECO	4-7	4688941	0186608	IVECO	4-16
4520744	0506984	IVECO	4-10	4688944	0187160	IVECO	4-18

RIF. ORIG O.E. NUMBER	RIF. OCAP REF. OCAP	MARCA	PAG.	RIF. ORIG O.E. NUMBER	RIF. OCAP REF. OCAP	MARCA	PAG.
4688948	0186599	IVECO	4-15	5000242485	0186758	RENAULT V.I.	8-12
4688949	0196599	IVECO	4-15	5000242486	0196598	RENAULT V.I.	8-12
4688951	0186656	IVECO	4-17	5000253852	0186598	RENAULT V.I.	8-12
4688952	0186655	IVECO	4-17	5000288360	0186598	RENAULT V.I.	8-12
4691212	0927387	IVECO	4-39	5000288361	0196598	RENAULT V.I.	8-12
4699246	0506716	IVECO	4-4	5000288362	0286641	RENAULT V.I.	8-13
4699305	0506717	IVECO	4-4	5000288363	0296641	RENAULT V.I.	8-13
4714134	0807207	IVECO	4-23	5000288364	0287892	RENAULT V.I.	8-15
4715615	0506839	IVECO	4-7	5000295214	0186424	RENAULT V.I.	8-12
4722108	0507161	IVECO	4-11	5000295215	0196424	RENAULT V.I.	8-12
4732041	0286610	IVECO	4-19	50003	0506690	RENAULT V.I.	8-7
4732546	0506720	IVECO	4-5	5000336305	0907263	RENAULT V.I.	8-23
4732549	0506721	IVECO	4-5	5000395435	0507202	RENAULT V.I.	8-8
4733704	0506750	IVECO	4-7	5000446681	0506699	RENAULT V.I.	8-1
4733752	0506723	IVECO	4-5	5000450713	0587990	RENAULT V.I.	8-20
4741171	0507165	IVECO	4-37	5000450714	0597990	RENAULT V.I.	8-20
4747960	0506840	IVECO	4-8	500053864	0289476	IVECO	4-21
4747961	0506840	IVECO	4-8	5000541230	0506690	RENAULT V.I.	8-7
4773359	0506820	IVECO	4-7	5000590236	0186598	RENAULT V.I.	8-12
4793166	0506826	IVECO	4-7	5000613598	0506939	RENAULT V.I.	8-2
4802443	0186598	IVECO	4-15	5000613837	0506697	RENAULT V.I.	8-1
4802444	0196598	IVECO	4-15	50007	0287291	RENAULT V.I.	8-14
4833820	0186424	IVECO	4-15	5000725267	0506676	RENAULT V.I.	8-5
4833821	0196424	IVECO	4-15	5000745719	0506677	RENAULT V.I.	8-5
4833822	0186598	IVECO	4-15	5000748784	0506642	RENAULT V.I.	8-5
4833823	0196598	IVECO	4-15	5000748868	0506642	RENAULT V.I.	8-5
4833825	0186613	IVECO	4-16	5000750976	0807252	RENAULT V.I.	8-16
4833826	0196613	IVECO	4-17	5000783574	0807252	RENAULT V.I.	8-16
4833827	0186424	IVECO	4-15	5000783889	0506642	RENAULT V.I.	8-5
4833828	0196424	IVECO	4-15	5000785429	0506751	RENAULT V.I.	8-8
4833829	0186598	IVECO	4-15	5000786902	0506695	RENAULT V.I.	8-1
4833830	0196598	IVECO	4-15	5000787304	0506676	RENAULT V.I.	8-5
4834037	0506820	IVECO	4-7	5000787305	0506676	RENAULT V.I.	8-5
4834041	0506826	IVECO	4-7	5000787306	0506676	RENAULT V.I.	8-5
48510-F3900	0509411	NISSAN	7-2	5000787472	0506680	RENAULT V.I.	8-6
48510-F3901	0509411	NISSAN	7-2	5000791330	0506677	RENAULT V.I.	8-5
48510-LA21D	0509411	NISSAN	7-2	5000793641	0907264	RENAULT V.I.	8-23
485109X100	0506590	NISSAN	7-2	5000793849	0927444	RENAULT V.I.	8-22
485109X101	0506590	NISSAN	7-2	5000794318	0927447	RENAULT V.I.	8-23
48510D8600	0506590	NISSAN	7-2	5000794319	0927445	RENAULT V.I.	8-23
48510F3900	0509411	NISSAN	7-2	5000794320	0927443	RENAULT V.I.	8-22
48510F3901	0509411	NISSAN	7-2	5000803459	0297350	RENAULT V.I.	8-14
48510LA20A	0506590	NISSAN	7-2	5000803460	0287350	RENAULT V.I.	8-14
48510LA21D	0509411	NISSAN	7-2	5000804824	0186598	RENAULT V.I.	8-12
485139X200	0186592	NISSAN	7-3	5000807536	0187228	RENAULT V.I.	8-21
485139X201	0196592	NISSAN	7-3	5000812483	0186424	RENAULT V.I.	8-12
485279X62A	0186592	NISSAN	7-3	5000816456	0297892	RENAULT V.I.	8-15
4854871	0506953	IVECO	4-2	5000819413	0907595	RENAULT V.I.	8-16
4854874	0506952	IVECO	4-9	5000823265	0196598	RENAULT V.I.	8-12
486479X62A	0196592	NISSAN	7-3	5000823987	0186613	RENAULT V.I.	8-12
50 01 852 452	0187723	RENAULT V.I.	8-13	5000858773	0186598	RENAULT V.I.	8-12
50 01 858 763	0187723	RENAULT V.I.	8-13	5000858774	0196598	RENAULT V.I.	8-12
50002	0297892	RENAULT V.I.	8-15	5000874577	0506642	RENAULT V.I.	8-5
5000212483	0186424	RENAULT V.I.	8-12	5000874578	0506642	RENAULT V.I.	8-5
5000240688	0186758	RENAULT V.I.	8-12	5000932435	0506693	RENAULT V.I.	8-8
5000242475	0186758	RENAULT V.I.	8-12	5001	0907595	RENAULT V.I.	8-16
5000242478	0196598	RENAULT V.I.	8-12	5001014345	0907252	RENAULT V.I.	8-16
5000242479	0186758	RENAULT V.I.	8-12	50018	0187903	RENAULT V.I.	8-13

RIF. ORIGINALE - RIF. OCAP - MARCA

CORRISPONDENZE RIFERIMENTI ORIGINALI

Cross Reference Guide - Vergleichenummern List - Liste D'equivalence - Guia De Intercambios

RIF. ORIG O.E. NUMBER	RIF. OCAP REF. OCAP	MARCA	PAG.	RIF. ORIG O.E. NUMBER	RIF. OCAP REF. OCAP	MARCA	PAG.
5001823718	0287320	RENAULT V.I.	8-14	5010092191	0506677	RENAULT V.I.	8-5
5001831473	0186424	RENAULT V.I.	8-12	5010094838	0807252	RENAULT V.I.	8-16
5001832579	0196599	RENAULT V.I.	8-13	5010094941	0807252	RENAULT V.I.	8-16
5001832581	0196598	RENAULT V.I.	8-12	5010098467	0507849	RENAULT V.I.	8-2
5001832582	0186424	RENAULT V.I.	8-12	50101	0506680	RENAULT V.I.	8-6
5001834533	0196424	RENAULT V.I.	8-12	50101030452	0506642	RENAULT V.I.	8-5
5001836297	0196598	RENAULT V.I.	8-12	5010130344	0506688	RENAULT V.I.	8-7
5001836298	0186598	RENAULT V.I.	8-12	5010130393	0506683	RENAULT V.I.	8-6
5001842337	0907304	RENAULT V.I.	8-18	5010130453	0506642	RENAULT V.I.	8-5
5001845430	0288930	RENAULT V.I.	8-15	5010130739	0506678	RENAULT V.I.	8-5
5001849879	0287361	RENAULT V.I.	8-14	5010138060	0506642	RENAULT V.I.	8-5
5001849880	0287360	RENAULT V.I.	8-14	5010138446	0506642	RENAULT V.I.	8-5
5001850530	0807252	RENAULT V.I.	8-16	5010138691	0506642	RENAULT V.I.	8-5
5001850549	0186424	RENAULT V.I.	8-12	5010144549	0506676	RENAULT V.I.	8-5
5001850550	0196424	RENAULT V.I.	8-12	5010144551	0506677	RENAULT V.I.	8-5
5001852263	0196424	RENAULT V.I.	8-12	5010144552	0506676	RENAULT V.I.	8-5
5001852452	0187723	RENAULT V.I.	8-13	5010144556	0506677	RENAULT V.I.	8-5
5001855163	0507677	RENAULT V.I.	8-8	5010144557	0506677	RENAULT V.I.	8-5
5001858759	0196598	RENAULT V.I.	8-12	5010145584	0507849	RENAULT V.I.	8-2
5001858760	0186598	RENAULT V.I.	8-12	50102	0507861	RENAULT V.I.	8-9
5001858763	0187723	RENAULT V.I.	8-13	5010229242	0506687	RENAULT V.I.	8-7
5001859984	0196424	RENAULT V.I.	8-12	5010239340	0506678	RENAULT V.I.	8-5
5001859985	0186424	RENAULT V.I.	8-12	5010239386	0506678	RENAULT V.I.	8-5
5001860769	0196595	RENAULT V.I.	8-13	5010239387	0506691	RENAULT V.I.	8-7
5001860770	0186595	RENAULT V.I.	8-12	5010253255	0597991	RENAULT V.I.	8-20
5001867774	0187903	RENAULT V.I.	8-13	5010253256	0587991	RENAULT V.I.	8-20
5001868363	0508736	RENAULT V.I.	8-3	5010291903	0507865	RENAULT V.I.	8-2
5001868366	0509911	RENAULT V.I.	8-3	5010294287	0506681	RENAULT V.I.	8-6
5001868374	0508721	RENAULT V.I.	8-9	5010294288	0506684	RENAULT V.I.	8-6
5001868383	0509412	RENAULT V.I.	8-10	5010294289	0506685	RENAULT V.I.	8-6
5001868384	0508723	RENAULT V.I.	8-10	5010294502	0506682	RENAULT V.I.	8-6
5001868385	0509460	RENAULT V.I.	8-10	5010294720	0507854	RENAULT V.I.	8-8
5003075	0506950	IVECO	4-2	50103	0507863	RENAULT V.I.	8-9
500310933	0280517	IVECO	4-35	5010308082	0506754	RENAULT V.I.	8-1
500324282	0507859	IVECO	4-14	5010383203	0508722	RENAULT V.I.	8-9
500334	0407250	IVECO	4-33	5010395796	0507864	RENAULT V.I.	8-9
500334486	0787250	IVECO	4-33	50104	0507856	RENAULT V.I.	8-2
500334487	0797250	IVECO	4-33	5010439023	0507865	RENAULT V.I.	8-2
500334713	0407249	IVECO	4-33	5010439631	0507849	RENAULT V.I.	8-2
500334714	0407249	IVECO	4-33	5010488084	0509439	RENAULT V.I.	8-10
500334716	0407250	IVECO	4-33	5010488097	0507988	RENAULT V.I.	8-9
500334717	0797250	IVECO	4-33	5010488164	0507861	RENAULT V.I.	8-9
500337201	0286616	IVECO	4-35	5010488167	0507863	RENAULT V.I.	8-9
5003404	0807299	IVECO	4-25	5010488464	0507884	RENAULT V.I.	8-9
500340452	0807292	IVECO	4-24	5010488639	0509439	RENAULT V.I.	8-10
500344887	0407249	IVECO	4-33	5010488759	0509439	RENAULT V.I.	8-10
500344888	0407249	IVECO	4-33	5010488836	0508722	RENAULT V.I.	8-9
500362533	0507852	IVECO	4-13	50105	0506679	RENAULT V.I.	8-5
500363545	0507853	IVECO	4-14	5010557341	0509439	RENAULT V.I.	8-10
500379801	0407249	IVECO	4-33	5010557523	0508722	RENAULT V.I.	8-9
500379802	0407249	IVECO	4-33	5010566049	0507864	RENAULT V.I.	8-9
500383975	0587871	IVECO	4-37	5010566059	0507855	RENAULT V.I.	8-2
500383976	0597871	IVECO	4-37	5010566062	0507865	RENAULT V.I.	8-2
500397738	0507369	IVECO	4-13	5010566063	0507858	RENAULT V.I.	8-2
5010037418	0506686	RENAULT V.I.	8-7	5010566064	0507856	RENAULT V.I.	8-2
5010060764	0506679	RENAULT V.I.	8-5	5010587004	0508736	RENAULT V.I.	8-3
5010064641	0807252	RENAULT V.I.	8-16	50106	0506685	RENAULT V.I.	8-6
5010092170	0506677	RENAULT V.I.	8-5	5010600822	0508736	RENAULT V.I.	8-3

RIF. ORIGINALE - RIF. OCAP - MARCA

CORRISPONDENZE RIFERIMENTI ORIGINALI

Cross Reference Guide - Vergleichenummern List - Liste D'equivalence - Guia De Intercambios

RIF. ORIG O.E. NUMBER	RIF. OCAP REF. OCAP	MARCA	PAG.	RIF. ORIG O.E. NUMBER	RIF. OCAP REF. OCAP	MARCA	PAG.
5010630255	0509463	RENAULT V.I.	8-10	607998	0196424	DAF	2-8
5010630434	0509435	RENAULT V.I.	8-3	607999	0186424	DAF	2-7
5010630637	0508721	RENAULT V.I.	8-9	6159082	0506746	IVECO	4-6
5010630638	0508721	RENAULT V.I.	8-9	61590910	0506741	IVECO	4-6
5010630812	0509460	RENAULT V.I.	8-10	61593332	0506743	IVECO	4-6
5010630813	0509460	RENAULT V.I.	8-10	61595371	0506745	IVECO	4-6
5010630820	0509412	RENAULT V.I.	8-10	61595957 *	0187158	IVECO	4-18
5010630821	0509412	RENAULT V.I.	8-10	61595960	0506746	IVECO	4-6
5010630822	0508723	RENAULT V.I.	8-10	6194602505	0506578	MERCEDES	6-4
5010630823	0508723	RENAULT V.I.	8-10	6194602905	0506578	MERCEDES	6-4
5010630980	0508998	RENAULT V.I.	8-10	6194605205	0506578	MERCEDES	6-4
5010832582	0186598	RENAULT V.I.	8-12	6204600005	0506575	MERCEDES	6-4
5010832583	0196598	RENAULT V.I.	8-12	6204602005	0506575	MERCEDES	6-4
504034521	0507866	IVECO	4-14	6204602805	0506575	MERCEDES	6-4
504039506	1215953	IVECO	4-31	6204603705	0506575	MERCEDES	6-4
504039506 *	0903144	IVECO	4-29	6243500006	0807611	MERCEDES	6-15
504049893	0507368	IVECO	4-13	62533	0507437	MERCEDES	6-1
504064007	0807296	IVECO	4-25	6253300603	0508967	MERCEDES	6-3
504144266	0509421	IVECO	4-3	6253302003	0508967	MERCEDES	6-3
504212	0407893	IVECO	4-35	6253302703	0508967	MERCEDES	6-3
504212586	0407893	IVECO	4-35	638862	0907259	SCANIA	9-9
513757	0907359	DAF	2-10	639287	0907259	SCANIA	9-9
525443	0506430	DAF	2-3	639370	0907528	SCANIA	9-8
542477	0187228	DAF	2-15	6474600005	0506962	MERCEDES	6-5
550257	0927454	SCANIA	9-11	6474600105	0506962	MERCEDES	6-5
550713	0927452	SCANIA	9-11	6593501106	0807611	MERCEDES	6-15
550714	0927452	SCANIA	9-11	6593503406	0807611	MERCEDES	6-15
550729	0927453	SCANIA	9-11	66746	0507905	MERCEDES	6-8
550730	0927453	SCANIA	9-11	6674601705	0507905	MERCEDES	6-8
550732	0927452	SCANIA	9-11	67303	0296428	DAF	2-9
550800	0907591	SCANIA	9-8	6734600605	0506583	MERCEDES	6-5
550806	0907528	SCANIA	9-8	67389	0286428	DAF	2-9
550808	0907528	SCANIA	9-8	6754601205	0506581	MERCEDES	6-5
55175540	0287238	IVECO	4-20	6754601805	0506581	MERCEDES	6-5
554765	0506430	DAF	2-3	6754602205	0506576	MERCEDES	6-4
58012	0507365	IVECO	4-12	6754602405	0506581	MERCEDES	6-5
5801282537	0507365	IVECO	4-12	6754603005	0506581	MERCEDES	6-5
5801304684	0807295	IVECO	4-25	67646	0507639	MERCEDES	6-7
5801378064	0407894	IVECO	4-36	6764601105	0506577	MERCEDES	6-4
5801384823	0807363	IVECO	4-26	6764601905	0507639	MERCEDES	6-7
5801564274	0909422	IVECO	4-30	6764603105	0507794	MERCEDES	6-8
5801564276	0909422	IVECO	4-30	67733	0506586	MERCEDES	6-1
5801564281	0909422	IVECO	4-30	6773300303	0506586	MERCEDES	6-1
5801564293	0709422	IVECO	4-32	6777855	0507116	VOLVO	10-6
5801564293 *	0409422	IVECO	4-32	6790572	0507115	VOLVO	10-6
5801564316	0709423	IVECO	4-32	67905729	0507115	VOLVO	10-6
5801564316 *	0409423	IVECO	4-32	6791948	0507116	VOLVO	10-6
580164	0507368	IVECO	4-13	6799189	0507121	VOLVO	10-7
580169	0509421	IVECO	4-3	67991893	0507121	VOLVO	10-7
5861533	0907586	IVECO	4-30	6851490000	0197467	MERCEDES	6-13
60103171	0506613	IVECO	4-1	6862225	0507109	VOLVO	10-1
606922	0296427	DAF	2-9	6884001	0196959	VOLVO	10-11
606923	0286427	DAF	2-8	6884002	0186959	VOLVO	10-11
607053	0196598	DAF	2-7	688450	0186598	DAF	2-7
607073	0186758	DAF	2-7	6885513	0907534	VOLVO	10-20
607451	0186613	DAF	2-7	6889478	0196959	VOLVO	10-11
607452	0196613	DAF	2-7	6889479	0186959	VOLVO	10-11
607981	0186598	DAF	2-7	6889483	0296964	VOLVO	10-13

RIF. ORIG O.E. NUMBER	RIF. OCAP REF. OCAP	MARCA	PAG.	RIF. ORIG O.E. NUMBER	RIF. OCAP REF. OCAP	MARCA	PAG.
6889484	0286964	VOLVO	10-13	7422159764	0509468	RENAULT V.I.	8-3
696205	0196598	DAF	2-7	7422163226	0509412	RENAULT V.I.	8-10
696225	0196598	DAF	2-7	7422163231	0509466	RENAULT V.I.	8-10
696226	0186758	DAF	2-7	7422163636	0509440	RENAULT V.I.	8-3
698609	0186424	DAF	2-7	7422325247	0507123	RENAULT V.I.	8-20
712758	0506642	RENAULT V.I.	8-5	7422380814	0509475	RENAULT V.I.	8-11
7136367	0507155	IVECO	4-11	7422482969	0507864	RENAULT V.I.	8-9
7160200	0927383	IVECO	4-39	7422526504	0509462	RENAULT V.I.	8-10
7161012	0927388	IVECO	4-40	7482292079	0508998	RENAULT V.I.	8-10
7161882	0927387	IVECO	4-39	74851	0506683	RENAULT V.I.	8-6
7162447	0927388	IVECO	4-40	7485104224	0907528	RENAULT V.I.	8-18
7162448	0927388	IVECO	4-40	7485114029	0287291	RENAULT V.I.	8-14
7162462	0927365	IVECO	4-39	7820249212	0606927	IVECO	4-22
7162586	0927387	IVECO	4-39	7981909	0187228	IVECO	4-38
7162624	0927365	IVECO	4-39	8122752	0186758	IVECO	4-18
7162882	0927365	IVECO	4-39	8122754	0186424	IVECO	4-15
7162998	0927365	IVECO	4-39	8122755	0196424	IVECO	4-15
7163000	0927365	IVECO	4-39	8123394	0196613	IVECO	4-17
7166166	0506904	IVECO	4-2	8131582	0506931	IVECO	4-9
7166166	0506904	RENAULT V.I.	8-1	8132397	0506931	IVECO	4-9
7166384	0506542	IVECO	4-1	8135446	0506897	IVECO	4-9
7167757	0186608	IVECO	4-16	8135492	0507287	IVECO	4-12
7173052	0927391	IVECO	4-40	8136061	0506927	IVECO	4-9
7173077	0927391	IVECO	4-40	8137027	0807358	IVECO	4-26
7173081	0927391	IVECO	4-40	8143	0807216	MAN	5-8
7173083	0927391	IVECO	4-40	81432206010	0807214	MAN	5-8
7173087	0927391	IVECO	4-40	81432206012	0807214	MAN	5-8
721608	0506642	RENAULT V.I.	8-5	81432206013	0807214	MAN	5-8
74031937	0288993	VOLVO	10-13	81432206020	0807214	MAN	5-8
7403193731	0288993	RENAULT V.I.	8-15	81432206035	0807214	MAN	5-8
7420448	0809443	VOLVO	10-17	81432206040	0807214	MAN	5-8
7420448089	0809443	RENAULT V.I.	8-17	81432206041	0807214	MAN	5-8
7420547286	0907919	RENAULT V.I.	8-17	81432206052	0807214	MAN	5-8
7420581086	0509914	RENAULT V.I.	8-4	81432206055	0907259	MAN	5-10
7420702095	0909994	RENAULT V.I.	8-17	81432206056	0807214	MAN	5-8
7420702096	0907359	RENAULT V.I.	8-18	81432206067	0807811	MAN	5-10
7420741703	0807913	RENAULT V.I.	8-17	81432206073	0907259	MAN	5-10
7420800194	0509374	RENAULT V.I.	8-20	81432206090	0807811	MAN	5-10
7420829503	0807762	RENAULT V.I.	8-16	81432206092	0807811	MAN	5-10
7420840815	0907763	RENAULT V.I.	8-16	81432206107	0907259	MAN	5-10
7420840820	0907762	RENAULT V.I.	8-16	81432206108	0907258	DAF	2-11
7420850454	0509433	RENAULT V.I.	8-20	81432206108	0907258	MAN	5-9
7420937674	0188994	RENAULT V.I.	8-13	81432206120	0807811	MAN	5-10
7421021395	0508998	RENAULT V.I.	8-10	81432206129	0807559	MAN	5-8
7421051052	0808738	RENAULT V.I.	8-17	81432206132	0907258	DAF	2-11
74211	0509473	RENAULT V.I.	8-3	81432206140	0807824	MAN	5-11
74212	0807762	RENAULT V.I.	8-16	81432206161	0807821	MAN	5-10
74214	0507123	RENAULT V.I.	8-20	81432206174	0807807	MAN	5-9
7421431678	0289456	RENAULT V.I.	8-15	81432206196	0807906	MAN	5-13
7421560825	0508721	RENAULT V.I.	8-9	81432206202	0907405	MAN	5-8
7421560838	0509471	RENAULT V.I.	8-11	81432206202	0907405	SCANIA	9-9
7421560848	0509467	RENAULT V.I.	8-11	81432206221	0807840	MAN	5-12
7421560865	0509412	RENAULT V.I.	8-10	81432206229	0807407	MAN	5-8
7421560882	0508723	RENAULT V.I.	8-10	81432206232	0807906	MAN	5-13
7421560892	0509460	RENAULT V.I.	8-10	81432206233	0807906	MAN	5-13
7421560957	0508736	RENAULT V.I.	8-3	81432206236	0807407	MAN	5-8
74216	0509462	RENAULT V.I.	8-10	81432206244	0907528	MAN	5-10
7422159755	0509473	RENAULT V.I.	8-3	81432206247	0807820	MAN	5-10

RIF. ORIGINALE - RIF. OCAP - MARCA

CORRISPONDENZE RIFERIMENTI ORIGINALI

Cross Reference Guide - Vergleichenummern List - Liste D'equivalence - Guia De Intercambios

RIF. ORIG O.E. NUMBER	RIF. OCAP REF. OCAP	MARCA	PAG.	RIF. ORIG O.E. NUMBER	RIF. OCAP REF. OCAP	MARCA	PAG.
81432206250	0907259	MAN	5-10	81432706126	0907840	MAN	5-12
81432206260	0807817	MAN	5-10	81432706135	0807842	MAN	5-13
81432206267	0807407	MAN	5-8	81432706137	0807839	MAN	5-11
81432206268	0807894	MAN	5-13	81432706145	0809988	MAN	5-14
81432206270	0807894	MAN	5-13	81432706146	0809988	MAN	5-14
81432206271	0809420	MAN	5-14	81432706147	0809988	MAN	5-14
81432206272	0807407	MAN	5-8	81432706150	0807839	MAN	5-11
81432206282	0809420	MAN	5-14	81432706151	0807841	MAN	5-12
81432206285	0909992	MAN	5-14	81432706160	0807842	MAN	5-13
81432206304	0807407	MAN	5-8	81432706161	0807842	MAN	5-13
81432206305	0807407	MAN	5-8	81437040074	1216303	MAN	5-18
81432206314	0809420	MAN	5-14	81437040077	1216306	MAN	5-18
81432206322	0907820	MAN	5-10	81437220021	1216305	MAN	5-18
81432206327	0809420	MAN	5-14	81437220022	1216304	MAN	5-18
81432206341	0807820	MAN	5-10	81437220038	1216304	MAN	5-18
81432206342	0807820	MAN	5-10	81437220039	1216305	MAN	5-18
81432206380	0807407	MAN	5-8	81437220062	1216302	MAN	5-18
81432206382	0807407	MAN	5-8	81437220063	1216305	MAN	5-18
81432206401	0807407	MAN	5-8	8146	0506445	MAN	5-3
81432209092	0807811	MAN	5-10	81466106280	0506444	MAN	5-3
81432209236	0807407	MAN	5-8	81466106288	0506445	MAN	5-3
81432209267	0807407	MAN	5-8	81466106374	0507955	MAN	5-5
81432209272	0807407	MAN	5-8	81466106579	0507848	MAN	5-2
81432209297	0807894	MAN	5-13	81466106580	0507848	MAN	5-2
81432306018	0807214	MAN	5-8	81466106583	0507848	MAN	5-2
81432306028	0807214	MAN	5-8	81466106624	0507848	MAN	5-2
81432306037	0807216	MAN	5-8	81466106640	0507848	MAN	5-2
81432306051	0907528	MAN	5-10	81466106692	0507815	MAN	5-4
81432306061	0907327	MAN	5-15	81466106693	0507815	MAN	5-4
81432306068	0907528	MAN	5-10	81466106695	0507815	MAN	5-4
81432701601	0809988	MAN	5-14	81466106721	0506443	MAN	5-3
81432706034	0807533	MAN	5-9	81466106753	0507839	MAN	5-5
81432706054	0807533	MAN	5-9	81466106754	0507839	MAN	5-5
81432706064	0907528	MAN	5-10	81466106779	0507822	MAN	5-4
81432706074	0807533	MAN	5-9	81466106780	0507822	MAN	5-4
81432706076	0807533	MAN	5-9	81466106782	0507822	MAN	5-4
81432706078	0807533	MAN	5-9	81466106790	0507820	MAN	5-4
81432706079	0907529	MAN	5-15	81466106791	0507820	MAN	5-4
81432706080	0907525	MAN	5-15	81466106813	0509415	MAN	5-5
81432706082	0807533	MAN	5-9	81466116003	0507409	MAN	5-4
81432706087	0807839	MAN	5-11	81466116004	0507409	MAN	5-4
81432706088	0807839	MAN	5-11	81466116005	0507409	MAN	5-4
81432706091	0907327	MAN	5-15	81466116019	0507955	MAN	5-5
81432706094	0807839	MAN	5-11	81466116087	0507917	MAN	5-5
81432706095	0807839	MAN	5-11	81466116096	0507917	MAN	5-5
81432706096	0807840	MAN	5-12	81466116097	0507917	MAN	5-5
81432706097	0807842	MAN	5-13	81466116104	0507408	MAN	5-3
81432706105	0907907	MAN	5-11	81466116105	0507408	MAN	5-3
81432706110	0907774	IVECO	4-27	81466116132	0507917	MAN	5-5
81432706110	0907774	MAN	5-11	81466116133	0507917	MAN	5-5
81432706113	0807842	MAN	5-13	81466116134	0507408	MAN	5-3
81432706114	0807840	MAN	5-12	81466116135	0507408	MAN	5-3
81432706116	0807841	MAN	5-12	81466116137	0507408	MAN	5-3
81432706117	0807907	MAN	5-13	81466116142	0509982	MAN	5-5
81432706118	0907840	MAN	5-12	81466116146	0509415	MAN	5-5
81432706121	0807840	MAN	5-12	81466116147	0509415	MAN	5-5
81432706122	0907683	MAN	5-16	81466116148	0509415	MAN	5-5
81432706123	0907840	MAN	5-12	81466116152	0509982	MAN	5-5

RIF. ORIG O.E. NUMBER	RIF. OCAP REF. OCAP	MARCA	PAG.	RIF. ORIG O.E. NUMBER	RIF. OCAP REF. OCAP	MARCA	PAG.
81466116161	0509982	MAN	5-5	81953010078	0196595	MAN	5-6
81466116162	0509982	MAN	5-5	81953010079	0196613	MAN	5-6
81466116163	0509982	MAN	5-5	81953016018	0289923	MAN	5-7
81466116197	0507917	MAN	5-5	81953016019	0289923	MAN	5-7
81466116198	0507917	MAN	5-5	81953016060	0186613	MAN	5-6
81466116199	0507408	MAN	5-3	81953016063	0297229	MAN	5-17
81466116200	0507408	MAN	5-3	81953016131	0297229	MAN	5-17
81466116204	0509415	MAN	5-5	81953016132	0907533	MAN	5-9
81466116205	0507917	MAN	5-5	81953016133	0907534	MAN	5-9
81466116206	0507408	MAN	5-3	81953016134	0186595	MAN	5-6
81467106112	0507807	MAN	5-1	81953016135	0186613	MAN	5-6
81467106163	0507807	MAN	5-1	81953016139	0196613	MAN	5-6
81467106165	0507807	MAN	5-1	81953016140	0186613	MAN	5-6
81467106167	0507817	MAN	5-1	81953016141	0196595	MAN	5-6
81467106198	0507807	MAN	5-1	81953016142	0186595	MAN	5-6
81467106353	0507807	MAN	5-1	81953016169	0187228	MAN	5-17
81467106354	0507807	MAN	5-1	81953016170	0287229	MAN	5-17
81467106361	0507807	MAN	5-1	81953016171	0297229	MAN	5-17
81467106442	0507846	MAN	5-1	81953016174	0297229	MAN	5-17
81467106443	0507846	MAN	5-1	81953016222	0196613	MAN	5-6
81467106460	0507846	MAN	5-1	81953016249	0186613	MAN	5-6
81467106785	0507843	MAN	5-1	81953016263	0186442	MAN	5-6
81467106830	0507817	MAN	5-1	81953016268	0289923	MAN	5-7
81467106846	0507843	MAN	5-1	81953016270	0187843	MAN	5-6
81467106865	0507841	MAN	5-1	81953016280	0287361	MAN	5-7
81467106866	0507841	MAN	5-1	81953016281	0287360	MAN	5-7
81467106932	0507843	MAN	5-1	81953016286	0188994	MAN	5-7
81467106933	0507843	MAN	5-1	81953016288	0187723	MAN	5-6
81467106934	0507843	MAN	5-1	81953016303	0186595	MAN	5-6
81467116711	0507843	MAN	5-1	81953016304	0196595	MAN	5-6
81467116717	0507841	MAN	5-1	81953016321	0186595	MAN	5-6
81467116720	0507848	MAN	5-2	81953016322	0196595	MAN	5-6
81467116725	0507807	MAN	5-1	81953016328	0186613	MAN	5-6
81467116728	0507841	MAN	5-1	81953016337	0287360	MAN	5-7
81467116736	0507817	MAN	5-1	81953016358	0186613	MAN	5-6
81467116773	0507915	MAN	5-2	81953020041	0907259	MAN	5-10
81467116803	0507814	MAN	5-1	81962100450	1216304	MAN	5-18
81467116805	0507814	MAN	5-1	81962100469	1216304	MAN	5-18
81467116820	0507807	MAN	5-1	8216556	0507863	VOLVO	10-8
81467116859	0507915	MAN	5-2	82432706005	0809988	MAN	5-14
81467116860	0507915	MAN	5-2	82432706007	0809988	MAN	5-14
81467116861	0507915	MAN	5-2	82466106080	0507955	MAN	5-5
81467116863	0507915	MAN	5-2	82466106189	0507955	MAN	5-5
81467116893	0507814	MAN	5-1	82466106190	0507955	MAN	5-5
81467116894	0507814	MAN	5-1	82466106191	0507820	MAN	5-4
81467116896	0507814	MAN	5-1	82953016016	0287360	MAN	5-7
81467116921	0507915	MAN	5-2	8483500106	0807669	MERCEDES	6-16
81467116933	0509417	MAN	5-2	85104224	0907528	VOLVO	10-16
8156991	0809386	VOLVO	10-17	85112073	0186959	VOLVO	10-11
8158207	0807687	VOLVO	10-14	85114144	0507101	VOLVO	10-4
8163773	0506932	IVECO	4-2	851142	0507113	VOLVO	10-6
8165309	0507288	IVECO	4-2	85115631	0509894	VOLVO	10-2
8178244	0287291	DAF	2-9	85125126	0186959	VOLVO	10-11
8193645	0186613	IVECO	4-16	8525704	0506993	IVECO	4-11
8193646	0196613	IVECO	4-17	8533963	0507171	IVECO	4-12
8195	0187723	MAN	5-6	8535664	0506991	IVECO	4-10
81953010022	0186758	MAN	5-6	8543	0907407	MAN	5-8
81953010077	0186595	MAN	5-6	85432206002	0907327	MAN	5-15

RIF. ORIG O.E. NUMBER	RIF. OCAP REF. OCAP	MARCA	PAG.	RIF. ORIG O.E. NUMBER	RIF. OCAP REF. OCAP	MARCA	PAG.
8546	0507812	MAN	5-4	93161720	0907304	IVECO	4-28
85466106006	0507839	MAN	5-5	93161958	0907297	IVECO	4-23
85466106019	0507215	MAN	5-3	93161960	0907296	IVECO	4-23
85466106020	0507815	MAN	5-4	93163617	0907927	IVECO	4-30
85466106021	0507533	MAN	5-4	93163828	0186598	IVECO	4-15
85466106031	0507839	MAN	5-5	93163964	0809418	IVECO	4-28
85466106102	0506446	MAN	5-3	93190752	0186598	IVECO	4-15
85466106104	0507839	MAN	5-5	93192361	0907327	IVECO	4-24
85466106119	0507215	MAN	5-3	93192618	0907304	IVECO	4-28
85466106121	0507533	MAN	5-4	93192619	0907330	IVECO	4-25
85466106140	0507533	MAN	5-4	93194626	0186612	IVECO	4-16
85466106150	0507215	MAN	5-3	93800662	0280515	IVECO	4-18
85466106151	0507815	MAN	5-4	93802209	0280517	IVECO	4-35
85466106162	0509968	MAN	5-5	93802242	0400518	IVECO	4-35
85466106203	0507839	MAN	5-5	93804059	0280515	IVECO	4-18
85466106219	0507215	MAN	5-3	93804060	0280517	IVECO	4-35
85466106221	0507533	MAN	5-4	93807320	0400518	IVECO	4-35
85466106246	0507812	MAN	5-4	93807545	0400518	IVECO	4-35
8558522	0506726	IVECO	4-5	93807640	1215270	IVECO	4-30
8558524	0196612	IVECO	4-16	93807641	1215269	IVECO	4-30
8558527	0186612	IVECO	4-16	93810239	1215271	IVECO	4-31
8558533	0186613	IVECO	4-16	93827647	0287552	IVECO	4-20
8558536	0196613	IVECO	4-17	94016	0506431	DAF	2-3
8558651	0506991	IVECO	4-10	94029	0506429	DAF	2-3
8558653	0507153	IVECO	4-11	94038	0506430	DAF	2-3
8564248	0506737	IVECO	4-5	9413300003	0507643	MERCEDES	6-2
8564386	0507290	IVECO	4-3	9413300007	0807636	MERCEDES	6-16
8565366	0186608	IVECO	4-16	9413300103	0507643	MERCEDES	6-2
8567618	0506736	IVECO	4-5	9413300203	0507643	MERCEDES	6-2
8567619	0506736	IVECO	4-5	9413300303	0507643	MERCEDES	6-2
8570528	0506812	IVECO	4-7	9413300503	0507643	MERCEDES	6-2
8573757	0507164	IVECO	4-11	9423300003	0507633	MERCEDES	6-2
8578492	0187234	IVECO	4-38	9423300103	0507633	MERCEDES	6-2
8578493	0187226	IVECO	4-38	9423300203	0507633	MERCEDES	6-2
858073	0286616	IVECO	4-35	9423300503	0508967	MERCEDES	6-3
8582313	0187226	IVECO	4-38	9423300903	0508967	MERCEDES	6-3
8582320	0507290	IVECO	4-3	9423301103	0507633	MERCEDES	6-2
8582322	0186613	IVECO	4-16	9423301903	0508967	MERCEDES	6-3
8582332	0186608	IVECO	4-16	9423500505	0807599	MERCEDES	6-15
8582333	0196608	IVECO	4-16	9423500805	0807599	MERCEDES	6-15
8582350	0506736	IVECO	4-5	9423501005	0807634	MERCEDES	6-15
8590435	0506887	IVECO	4-8	9423501205	0807599	MERCEDES	6-15
8590443	0506737	IVECO	4-5	9423501505	0807634	MERCEDES	6-15
8590479	0506726	IVECO	4-5	9443301703	0507437	MERCEDES	6-1
8591219	0506737	IVECO	4-5	9443500005	0807634	MERCEDES	6-15
8591222	0506726	IVECO	4-5	9443500305	0807634	MERCEDES	6-15
86011651	0506827	IVECO	4-1	9443500505	0807774	MERCEDES	6-16
86012923	0506904	IVECO	4-2	9453300003	0507916	MERCEDES	6-2
86012923	0506904	RENAULT V.I.	8-1	9453300007	0807635	MERCEDES	6-16
86012924	0507323	IVECO	4-3	9453300103	0507916	MERCEDES	6-2
86018015	0506827	IVECO	4-1	9453300203	0507651	MERCEDES	6-2
8788387	0506738	IVECO	4-6	9453300303	0507651	MERCEDES	6-2
8788641	0506740	IVECO	4-6	9453300403	0507916	MERCEDES	6-2
9009501	0186614	IVECO	4-17	9453300503	0507651	MERCEDES	6-2
9009503	0196614	IVECO	4-17	9453300603	0507916	MERCEDES	6-2
93161371	0907578	IVECO	4-30	9453500105	0808975	MERCEDES	6-17
9316163	0907297	IVECO	4-23	9473500005	0807669	MERCEDES	6-16
93161631	0907299	IVECO	4-26	9473500105	0807634	MERCEDES	6-15

RIF. ORIGINALE - RIF. OCAP - MARCA

CORRISPONDENZE RIFERIMENTI ORIGINALI

Cross Reference Guide - Vergleichenummern List - Liste D'equivalence - Guia De Intercambios

RIF. ORIG O.E. NUMBER	RIF. OCAP REF. OCAP	MARCA	PAG.	RIF. ORIG O.E. NUMBER	RIF. OCAP REF. OCAP	MARCA	PAG.
9473500605	0807669	MERCEDES	6-16	9753302503	0507975	MERCEDES	6-2
9473500705	0807634	MERCEDES	6-15	98402544	0506951	IVECO	4-9
9473500905	0807774	MERCEDES	6-16	98402553	0506950	IVECO	4-2
9473501005	0807634	MERCEDES	6-15	9842766	0506817	IVECO	4-1
94835	0807908	MERCEDES	6-17	98446354	0506894	IVECO	4-8
9483500006	0807669	MERCEDES	6-16	9844902	0506956	IVECO	4-10
9483500405	0807774	MERCEDES	6-16	98458724	0506817	IVECO	4-1
9483500805	0807669	MERCEDES	6-16	9846745	0506951	IVECO	4-9
9483500905	0808986	MERCEDES	6-18	98469650	0506956	IVECO	4-10
9483501005	0808975	MERCEDES	6-17	98470968	0506994	IVECO	4-2
9483501205	0807669	MERCEDES	6-16	98472466	0807358	IVECO	4-26
9483501305	0807669	MERCEDES	6-16	98472468	0807296	IVECO	4-25
9483502005	0807669	MERCEDES	6-16	98472871	0807336	IVECO	4-26
9483502205	0807908	MERCEDES	6-17	98473328	0507850	IVECO	4-13
9483502405	0807669	MERCEDES	6-16	98493054	0507851	IVECO	4-13
9483502505	0808975	MERCEDES	6-17	9945857	0809418	IVECO	4-28
9483502905	0808982	MERCEDES	6-18	9946326	0607552	IVECO	4-22
9483503005	0807774	MERCEDES	6-16	9983325	0600516	IVECO	4-22
9493300203	0507591	MERCEDES	6-1	A0003305248	0186758	MERCEDES	6-13
9493300303	0507591	MERCEDES	6-1	A0003406169	0186758	MERCEDES	6-13
9493300603	0507603	MERCEDES	6-1	A0003406251	0186758	MERCEDES	6-13
9493300703	0507603	MERCEDES	6-1	A0014608948	0187789	MERCEDES	6-14
9493300803	0507591	MERCEDES	6-1	ACHF060	0186598	DAF	2-7
9493300903	0507591	MERCEDES	6-1	ACHF241	0196424	DAF	2-8
9493301003	0507436	MERCEDES	6-1	ACU9239	0197803	DAF	2-8
9493301103	0507436	MERCEDES	6-1	ACU9240	0187803	DAF	2-8
9493301503	0507603	MERCEDES	6-1	ACU9242	0186613	DAF	2-7
9493301603	0507603	MERCEDES	6-1	AFRA635	0197928	DAF	2-8
9493301703	0507436	MERCEDES	6-1	AFRA888	0187803	DAF	2-8
9493302003	0507603	MERCEDES	6-1	HJK3891	0506417	DAF	2-3
9493302403	0507603	MERCEDES	6-1	HJK3892	0506167	DAF	2-1
95746	0507972	MERCEDES	6-10				
9574600405	0508939	MERCEDES	6-10				
9574600505	0507972	MERCEDES	6-10				
9603300403	0509442	MERCEDES	6-3				
9603500906	0809444	MERCEDES	6-19				
9703300003	0506167	DAF	2-1				
9703300003	0509391	MERCEDES	6-3				
9703300103	0506167	DAF	2-1				
9703300203	0506167	DAF	2-1				
9703300303	0506167	DAF	2-1				
9703300403	0506167	DAF	2-1				
97046	0507613	MERCEDES	6-6				
9704600905	0507613	MERCEDES	6-6				
97246	0507439	MERCEDES	6-6				
9724601405	0507439	MERCEDES	6-6				
9724601805	0507827	MERCEDES	6-8				
9724602005	0507827	MERCEDES	6-8				
9743500005	0808987	MERCEDES	6-18				
9743500405	0808987	MERCEDES	6-18				
9743500505	0808987	MERCEDES	6-18				
9744601005	0507887	MERCEDES	6-8				
9744601105	0507963	MERCEDES	6-9				
9744601205	0507887	MERCEDES	6-8				
9744601305	0507963	MERCEDES	6-9				
9753300203	0507975	MERCEDES	6-2				
9753300303	0507975	MERCEDES	6-2				
9753300803	0507975	MERCEDES	6-2				

RIF. OCAP - RIF. ORIGINALE - MARCA

CORRISPONDENZE RIFERIMENTI ORIGINALI

Cross Reference Guide - Vergleichenummern List - Liste D'equivalence - Guia De Intercambios

RIF. OCAP REF. OCAP	RIF. ORIG O.E. NUMBER	MARCA	PAG.	RIF. OCAP REF. OCAP	RIF. ORIG O.E. NUMBER	MARCA	PAG.
0181785	4121848	IVECO	4-38	0187228	0386930	DAF	2-15
0182344	-	RENAULT V.I.	8-12	0187228	7981909	IVECO	4-38
0186168	1604248	DAF	2-7	0187228	81953016169	MAN	5-17
0186424	1229944	DAF	2-7	0187228	5000807536	RENAULT V.I.	8-21
0186424	2966688	IVECO	4-15	0187230	0350270	SCANIA	9-10
0186424	0003307335	MERCEDES	6-12	0187231	1383405	SCANIA	9-10
0186424	5000212483	RENAULT V.I.	8-12	0187234	8578492	IVECO	4-38
0186442	81953016263	MAN	5-6	0187241	1527234	VOLVO	10-24
0186547	0013300335	MERCEDES	6-12	0187346	-	RENAULT V.I.	8-21
0186551	0004605748	MERCEDES	6-12	0187467	0004601748	MERCEDES	6-13
0186592	11200360-0	NISSAN	7-3	0187686	3093647	VOLVO	10-12
0186595	81953010077	MAN	5-6	0187723	1149875	DAF	2-7
0186595	5001860770	RENAULT V.I.	8-12	0187723	8195	MAN	5-6
0186598	1149907	DAF	2-7	0187723	50 01 852 452	RENAULT V.I.	8-13
0186598	42483386	IVECO	4-15	0187723	20894438	VOLVO	10-12
0186598	0004601048	MERCEDES	6-12	0187789	0014604148	MERCEDES	6-14
0186598	5000253852	RENAULT V.I.	8-12	0187803	ACU9240	DAF	2-8
0186598	0395010	SCANIA	9-6	0187843	81953016270	MAN	5-6
0186598	20742127	VOLVO	10-11	0187891	0023123262 *	RENAULT V.I.	8-13
0186599	4688948	IVECO	4-15	0187894	1723897	SCANIA	9-6
0186603	4018036	IVECO	4-15	0187903	50018	RENAULT V.I.	8-13
0186604	4028250	IVECO	4-15	0187916	0014602948	MERCEDES	6-14
0186605	4510019	IVECO	4-16	0187922	-	HYUNDAI	3-1
0186608	4688941	IVECO	4-16	0187959	0014603848	MERCEDES	6-14
0186612	42487165	IVECO	4-16	0188994	1685552	DAF	2-8
0186612	0003301235	MERCEDES	6-13	0188994	42538384	IVECO	4-18
0186612	1696919	VOLVO	10-11	0188994	81953016286	MAN	5-7
0186613	0110197	DAF	2-7	0188994	7420937674	RENAULT V.I.	8-13
0186613	2966321	IVECO	4-16	0188994	1358793	SCANIA	9-6
0186613	81953016060	MAN	5-6	0188994	20937674	VOLVO	10-12
0186613	0003301435	MERCEDES	6-13	0189896	21263974	VOLVO	10-12
0186613	5000823987	RENAULT V.I.	8-12	0189914	20581089	VOLVO	10-12
0186614	4579231	IVECO	4-17	0196168	1604247	DAF	2-8
0186648	4665007	IVECO	4-17	0196424	1315447	DAF	2-8
0186649	4665005	IVECO	4-17	0196424	2984511	IVECO	4-15
0186655	4688952	IVECO	4-17	0196424	0013308835	MERCEDES	6-12
0186656	4688951	IVECO	4-17	0196424	5000295215	RENAULT V.I.	8-12
0186657	4520697	IVECO	4-17	0196547	-	MERCEDES	6-12
0186684	4580778	IVECO	4-17	0196592	11200361-0	NISSAN	7-3
0186758	607073	DAF	2-7	0196595	81953010078	MAN	5-6
0186758	042489573	IVECO	4-18	0196595	5001860769	RENAULT V.I.	8-13
0186758	81953010022	MAN	5-6	0196598	1228115	DAF	2-7
0186758	A0003305248	MERCEDES	6-13	0196598	42489395	IVECO	4-15
0186758	5000240688	RENAULT V.I.	8-12	0196598	0004603448	MERCEDES	6-12
0186758	1337367	SCANIA	9-6	0196598	5000242478	RENAULT V.I.	8-12
0186758	20742127	VOLVO	10-11	0196598	1358792	SCANIA	9-6
0186946	3090472	VOLVO	10-11	0196599	4688949	IVECO	4-15
0186948	1506269	VOLVO	10-11	0196599	5001832579	RENAULT V.I.	8-13
0186949	41005523	IVECO	4-38	0196603	4018037	IVECO	4-18
0186959	1505759	VOLVO	10-11	0196604	4028251	IVECO	4-16
0186960	1507826	VOLVO	10-12	0196605	4523292	IVECO	4-16
0187146	0004602648	MERCEDES	6-13	0196608	1689605	DAF	2-8
0187152	4580782	IVECO	4-18	0196608	8582333	IVECO	4-16
0187156	2463583	IVECO	4-35	0196612	8558524	IVECO	4-16
0187157	2460515	IVECO	4-35	0196612	0003301235	MERCEDES	6-13
0187158	61595957 *	IVECO	4-18	0196613	1373137	DAF	2-7
0187160	4688944	IVECO	4-18	0196613	2969507	IVECO	4-17
0187226	8578493	IVECO	4-38	0196613	81953010079	MAN	5-6

RIF. OCAP REF. OCAP	RIF. ORIG O.E. NUMBER	MARCA	PAG.	RIF. OCAP REF. OCAP	RIF. ORIG O.E. NUMBER	MARCA	PAG.
0196614	4579232	IVECO	4-17	0289426	42569562	IVECO	4-20
0196758	1337366	SCANIA	9-6	0289455	1394447	SCANIA	9-7
0196946	3090728	VOLVO	10-13	0289456	7421431678	RENAULT V.I.	8-15
0196959	1505758	VOLVO	10-11	0289456	21431678	VOLVO	10-13
0196960	1131744	VOLVO	10-12	0289476	500053864	IVECO	4-21
0196961	0004606148	MERCEDES	6-14	0289923	4253044	IVECO	4-21
0197146	0014607448	MERCEDES	6-13	0289923	81953016018	MAN	5-7
0197467	6851490000	MERCEDES	6-13	0289923	3090291	VOLVO	10-13
0197803	ACU9239	DAF	2-8	0291786	41002119	IVECO	4-38
0197922	-	HYUNDAI	3-1	0296427	606922	DAF	2-9
0197928	1401942	DAF	2-8	0296428	67303	DAF	2-9
0199914	20710008	VOLVO	10-12	0296606	4510018	IVECO	4-19
0280515	1903652	IVECO	4-18	0296641	5000288363	RENAULT V.I.	8-13
0280517	500310933	IVECO	4-35	0296759	0310979	SCANIA	9-6
0281786	41203863	IVECO	4-38	0296964	1131741	VOLVO	10-13
0286427	606923	DAF	2-8	0297074	-	RENAULT V.I.	8-14
0286428	67389	DAF	2-9	0297229	81953016063	MAN	5-17
0286606	4510017	IVECO	4-18	0297350	5000803459	RENAULT V.I.	8-14
0286610	4514235	IVECO	4-19	0297892	50002	RENAULT V.I.	8-15
0286616	500337201	IVECO	4-35	0400518	93802242	IVECO	4-35
0286641	5000288362	RENAULT V.I.	8-13	0407249	500334713	IVECO	4-33
0286647	4665009	IVECO	4-19	0407250	500334	IVECO	4-33
0286650	4514245	IVECO	4-19	0407893	504212	IVECO	4-35
0286652	4582159	IVECO	4-19	0407894	5801378064	IVECO	4-36
0286658	4665422	IVECO	4-19	0409422	5801564293 *	IVECO	4-32
0286665	4025438	IVECO	4-19	0409423	5801564316 *	IVECO	4-32
0286759	031098	SCANIA	9-6	0506026	0001146170	RENAULT V.I.	8-1
0286964	1131742	VOLVO	10-13	0506167	9703300003	DAF	2-1
0287074	-	RENAULT V.I.	8-14	0506168	1407963	DAF	2-1
0287150	4664090	IVECO	4-19	0506417	HJK3891	DAF	2-3
0287229	81953016170	MAN	5-17	0506429	0117343	DAF	2-3
0287238	55175540	IVECO	4-20	0506430	0554765	DAF	2-3
0287291	8178244	DAF	2-9	0506431	0171215	DAF	2-3
0287291	50007	RENAULT V.I.	8-14	0506432	1286343	DAF	2-1
0287320	42530316	IVECO	4-20	0506433	1291060	DAF	2-3
0287320	5001823718	RENAULT V.I.	8-14	0506434	1247957	DAF	2-3
0287350	5000803460	RENAULT V.I.	8-14	0506435	1247956	DAF	2-4
0287360	42533101	IVECO	4-20	0506443	81466106721	MAN	5-3
0287360	81953016281	MAN	5-7	0506444	81466106280	MAN	5-3
0287360	5001849880	RENAULT V.I.	8-14	0506445	8146	MAN	5-3
0287360	1394444	SCANIA	9-7	0506446	85466106102	MAN	5-3
0287361	42533073	IVECO	4-20	0506542	7166384	IVECO	4-1
0287361	81953016280	MAN	5-7	0506575	3874600405	MERCEDES	6-4
0287361	5001849879	RENAULT V.I.	8-14	0506576	6754602205	MERCEDES	6-4
0287361	1394443	SCANIA	9-7	0506577	6764601105	MERCEDES	6-4
0287503	1399724	DAF	2-9	0506578	6194602505	MERCEDES	6-4
0287552	42534911	IVECO	4-20	0506579	3874600005	MERCEDES	6-4
0287684	0004604948	MERCEDES	6-14	0506580	3874600605	MERCEDES	6-4
0287684	1912759	SCANIA	9-7	0506581	6754601205	MERCEDES	6-5
0287892	5000288364	RENAULT V.I.	8-15	0506582	0014603	MERCEDES	6-5
0287906	42533102	IVECO	4-20	0506583	6734600605	MERCEDES	6-5
0288003	-	IVECO	4-20	0506584	3834600805	MERCEDES	6-5
0288779	20374698	VOLVO	10-13	0506585	0004607105	MERCEDES	6-5
0288930	00246	MERCEDES	6-14	0506586	67733	MERCEDES	6-1
0288930	50018	RENAULT V.I.	8-15	0506588	11200265-0	NISSAN	7-1
0288993	31937	RENAULT V.I.	8-15	0506590	11200454-0	NISSAN	7-2
0288993	3193731	VOLVO	10-13	0506591	11505036-0	NISSAN	7-2
0289425	42569563	IVECO	4-20	0506613	60103171	IVECO	4-1

RIF. OCAP - RIF. ORIGINALE - MARCA

CORRISPONDENZE RIFERIMENTI ORIGINALI

Cross Reference Guide - Vergleichenummern List - Liste D'equivalence - Guia De Intercambios

RIF. OCAP REF. OCAP	RIF. ORIG O.E. NUMBER	MARCA	PAG.	RIF. OCAP REF. OCAP	RIF. ORIG O.E. NUMBER	MARCA	PAG.
0506642	0023123247	RENAULT V.I.	8-5	0506869	1304571	SCANIA	9-2
0506676	5000725267	RENAULT V.I.	8-5	0506887	8590435	IVECO	4-8
0506677	5000745719	RENAULT V.I.	8-5	0506888	345124	SCANIA	9-2
0506678	5010130739	RENAULT V.I.	8-5	0506889	278663	SCANIA	9-2
0506679	5010060764	RENAULT V.I.	8-5	0506894	98446354	IVECO	4-8
0506680	5000787472	RENAULT V.I.	8-6	0506897	41005472	IVECO	4-9
0506681	5010294287	RENAULT V.I.	8-6	0506904	42037386	IVECO	4-2
0506682	5010294502	RENAULT V.I.	8-6	0506904	42037386	RENAULT V.I.	8-1
0506683	5010130393	RENAULT V.I.	8-6	0506913	390784	SCANIA	9-3
0506684	5010294288	RENAULT V.I.	8-6	0506914	291398	SCANIA	9-3
0506685	5010294289	RENAULT V.I.	8-6	0506916	1308643	SCANIA	9-3
0506686	5010037418	RENAULT V.I.	8-7	0506918	306981	SCANIA	9-3
0506687	5010229242	RENAULT V.I.	8-7	0506919	1369919	SCANIA	9-3
0506688	5010130344	RENAULT V.I.	8-7	0506920	1356055	SCANIA	9-3
0506689	0023123262	RENAULT V.I.	8-7	0506927	41005466	IVECO	4-9
0506690	50003	RENAULT V.I.	8-7	0506931	41005463	IVECO	4-9
0506691	50101	RENAULT V.I.	8-7	0506932	41005450	IVECO	4-2
0506693	5000932435	RENAULT V.I.	8-8	0506936	1112511	SCANIA	9-4
0506695	5000786902	RENAULT V.I.	8-1	0506937	1385251	SCANIA	9-1
0506697	5000613837	RENAULT V.I.	8-1	0506939	5000613598	RENAULT V.I.	8-2
0506699	5000446681	RENAULT V.I.	8-1	0506939	1723896	SCANIA	9-1
0506709	4626917	IVECO	4-4	0506950	5003075	IVECO	4-2
0506710	4665209	IVECO	4-4	0506951	98402544	IVECO	4-9
0506711	4665501	IVECO	4-4	0506952	4854874	IVECO	4-9
0506712	4520694	IVECO	4-4	0506953	4854871	IVECO	4-2
0506716	4699246	IVECO	4-4	0506955	42117267	IVECO	4-9
0506717	4699305	IVECO	4-4	0506956	9844902	IVECO	4-10
0506720	4624032	IVECO	4-5	0506962	3874600705	MERCEDES	6-5
0506721	4624116	IVECO	4-5	0506963	3834600605	MERCEDES	6-6
0506723	4666933	IVECO	4-5	0506965	1584620	VOLVO	10-4
0506726	8558522	IVECO	4-5	0506966	1505857	VOLVO	10-4
0506736	8567618	IVECO	4-5	0506967	1610338	VOLVO	10-4
0506737	8564248	IVECO	4-5	0506968	1613562	VOLVO	10-4
0506738	8788387	IVECO	4-6	0506971	4668258	IVECO	4-10
0506740	8788641	IVECO	4-6	0506976	4588688	IVECO	4-10
0506741	61590910	IVECO	4-6	0506977	4568702	IVECO	4-10
0506743	61593332	IVECO	4-6	0506984	4520744	IVECO	4-10
0506745	61595371	IVECO	4-6	0506987	4545422	IVECO	4-10
0506746	6159082	IVECO	4-6	0506991	8535664	IVECO	4-10
0506750	4666991	IVECO	4-7	0506993	8525704	IVECO	4-11
0506751	5000785429	RENAULT V.I.	8-8	0506994	98470968	IVECO	4-2
0506753	4520698	IVECO	4-7	0507100	1592940	VOLVO	10-4
0506754	5010308082	RENAULT V.I.	8-1	0507101	1592939	VOLVO	10-4
0506788	247605	IVECO	4-1	0507103	1576816	VOLVO	10-5
0506812	8570528	IVECO	4-7	0507104	1610074	VOLVO	10-5
0506816	0278665	SCANIA	9-2	0507105	1080788	VOLVO	10-5
0506817	9842766	IVECO	4-1	0507106	1080787	VOLVO	10-5
0506820	4773359	IVECO	4-7	0507107	1075005	VOLVO	10-5
0506826	4793166	IVECO	4-7	0507108	1691660	VOLVO	10-5
0506827	42037384	IVECO	4-1	0507109	1505855	VOLVO	10-1
0506829	352637	SCANIA	9-2	0507111	1075663	VOLVO	10-6
0506839	4715615	IVECO	4-7	0507112	1075153	VOLVO	10-6
0506840	42087842	IVECO	4-8	0507113	1628636	VOLVO	10-6
0506846	291395	SCANIA	9-2	0507114	1080786	VOLVO	10-6
0506847	41036943	IVECO	4-1	0507115	20400941	VOLVO	10-6
0506848	42042950	IVECO	4-8	0507116	20400909	VOLVO	10-6
0506855	42001325	IVECO	4-8	0507117	1071169	VOLVO	10-7
0506856	42043293	IVECO	4-8	0507118	1071344	VOLVO	10-7

RIF. OCAP - RIF. ORIGINALE - MARCA

CORRISPONDENZE RIFERIMENTI ORIGINALI

Cross Reference Guide - Vergleichenummern List - Liste D'equivalence - Guia De Intercambios

RIF. OCAP REF. OCAP	RIF. ORIG O.E. NUMBER	MARCA	PAG.	RIF. OCAP REF. OCAP	RIF. ORIG O.E. NUMBER	MARCA	PAG.
0507119	1094912	VOLVO	10-7	0507766	1343283	SCANIA	9-4
0507120	1075664	VOLVO	10-7	0507767	1343266	SCANIA	9-4
0507121	3124962	VOLVO	10-7	0507789	0024604505	MERCEDES	6-8
0507122	1071315	VOLVO	10-7	0507794	6764603105	MERCEDES	6-8
0507123	74214	RENAULT V.I.	8-20	0507807	81467106112	MAN	5-1
0507123	21446333	VOLVO	10-22	0507812	8546	MAN	5-4
0507124	1626637	VOLVO	10-1	0507814	81467116803	MAN	5-1
0507153	8558653	IVECO	4-11	0507815	81466106692	MAN	5-4
0507154	4546822	IVECO	4-11	0507817	81467106167	MAN	5-1
0507155	7136367	IVECO	4-11	0507820	81466106790	MAN	5-4
0507161	4722108	IVECO	4-11	0507822	81466106779	MAN	5-4
0507164	8573757	IVECO	4-11	0507827	0034605905	MERCEDES	6-8
0507165	4741171	IVECO	4-37	0507839	81466106753	MAN	5-5
0507171	8533963	IVECO	4-12	0507841	81467106865	MAN	5-1
0507188	382774	SCANIA	9-4	0507843	81467106785	MAN	5-1
0507202	50003	RENAULT V.I.	8-8	0507846	81467106442	MAN	5-1
0507207	41032826	IVECO	4-12	0507848	81466106579	MAN	5-2
0507215	85466106019	MAN	5-3	0507849	5010098467	RENAULT V.I.	8-2
0507221	20443062	VOLVO	10-22	0507850	98473328	IVECO	4-13
0507253	213123	RENAULT V.I.	8-8	0507851	98493054	IVECO	4-13
0507287	41005469	IVECO	4-12	0507852	500362533	IVECO	4-13
0507288	8165309	IVECO	4-2	0507853	500363545	IVECO	4-14
0507290	8564386	IVECO	4-3	0507854	5010294720	RENAULT V.I.	8-8
0507293	41005475	IVECO	4-12	0507855	5010566059	RENAULT V.I.	8-2
0507314	4211553	IVECO	4-12	0507856	50104	RENAULT V.I.	8-2
0507323	86012924	IVECO	4-3	0507858	50104	RENAULT V.I.	8-2
0507365	58012	IVECO	4-12	0507859	500324282	IVECO	4-14
0507366	410326	IVECO	4-3	0507861	50102	RENAULT V.I.	8-9
0507368	504049893	IVECO	4-13	0507863	50103	RENAULT V.I.	8-9
0507369	500397738	IVECO	4-13	0507863	20709844	VOLVO	10-8
0507370	4121516	IVECO	4-13	0507864	5010395796	RENAULT V.I.	8-9
0507408	81466116104	MAN	5-3	0507865	5010291903	RENAULT V.I.	8-2
0507409	81466116003	MAN	5-4	0507866	504034521	IVECO	4-14
0507436	9493301003	MERCEDES	6-1	0507884	5010488464	RENAULT V.I.	8-9
0507437	62533	MERCEDES	6-1	0507887	0034604605	MERCEDES	6-8
0507439	97246	MERCEDES	6-6	0507904	4102826	IVECO	4-14
0507533	85466106021	MAN	5-4	0507905	66746	MERCEDES	6-8
0507587	0014601505	MERCEDES	6-1	0507911	0014601305	MERCEDES	6-9
0507591	9493300203	MERCEDES	6-1	0507912	0024605205	MERCEDES	6-9
0507603	9493300603	MERCEDES	6-1	0507915	81467116773	MAN	5-2
0507610	3913300603	MERCEDES	6-2	0507916	9453300003	MERCEDES	6-2
0507611	4244600305	MERCEDES	6-6	0507917	81466116087	MAN	5-5
0507613	97046	MERCEDES	6-6	0507918	20443061	VOLVO	10-22
0507614	0024609605	MERCEDES	6-6	0507933	1270853	DAF	2-1
0507615	0024605	MERCEDES	6-6	0507934	0288281	DAF	2-1
0507617	4054600005	MERCEDES	6-7	0507936	139264	DAF	2-4
0507627	00046098	MERCEDES	6-7	0507937	1451118	DAF	2-4
0507630	0024604305	MERCEDES	6-7	0507938	1380417	DAF	2-4
0507631	0024604705	MERCEDES	6-7	0507942	1297572	DAF	2-1
0507632	0014609805	MERCEDES	6-7	0507947	1395994	DAF	2-4
0507633	9423300003	MERCEDES	6-2	0507948	1363859	DAF	2-4
0507639	67646	MERCEDES	6-7	0507949	1700000	DAF	2-2
0507642	0034601805	MERCEDES	6-8	0507955	81466106374	MAN	5-5
0507643	9413300003	MERCEDES	6-2	0507961	0014601105	MERCEDES	6-9
0507651	9453300203	MERCEDES	6-2	0507962	0024606105	MERCEDES	6-9
0507677	0023123268	RENAULT V.I.	8-8	0507963	0034600705	MERCEDES	6-9
0507723	1361413	SCANIA	9-1	0507965	0024605905	MERCEDES	6-9
0507731	1379072	SCANIA	9-4	0507967	0004609	MERCEDES	6-10

RIF. OCAP - RIF. ORIGINALE - MARCA

CORRISPONDENZE RIFERIMENTI ORIGINALI

Cross Reference Guide - Vergleichenummern List - Liste D'equivalence - Guia De Intercambios

RIF. OCAP REF. OCAP	RIF. ORIG O.E. NUMBER	MARCA	PAG.	RIF. OCAP REF. OCAP	RIF. ORIG O.E. NUMBER	MARCA	PAG.
0507968	0014600705	MERCEDES	6-10	0509466	7422163231	RENAULT V.I.	8-10
0507972	95746	MERCEDES	6-10	0509466	22163223	VOLVO	10-9
0507975	9753300203	MERCEDES	6-2	0509467	7421560848	RENAULT V.I.	8-11
0507988	50103	RENAULT V.I.	8-9	0509468	7422159764	RENAULT V.I.	8-3
0507999	1343262	SCANIA	9-4	0509468	21261985	VOLVO	10-2
0508721	5001868374	RENAULT V.I.	8-9	0509469	1807596	DAF	2-2
0508722	5010383203	RENAULT V.I.	8-9	0509470	0034608605	MERCEDES	6-11
0508723	5001868384	RENAULT V.I.	8-10	0509471	7421560838	RENAULT V.I.	8-11
0508723	20727843	VOLVO	10-8	0509472	22159758	VOLVO	10-2
0508736	5001868363	RENAULT V.I.	8-3	0509473	74211	RENAULT V.I.	8-3
0508736	21560957	VOLVO	10-1	0509473	2119277	VOLVO	10-2
0508758	1723896	SCANIA	9-1	0509474	1426101	DAF	2-5
0508786	20477807	VOLVO	10-22	0509475	74216	RENAULT V.I.	8-11
0508787	20443063	VOLVO	10-22	0509475	22380814	VOLVO	10-9
0508799	20390745	VOLVO	10-8	0509477	2636650	SCANIA	9-5
0508939	95746	MERCEDES	6-10	0509879	1343264	SCANIA	9-5
0508957	0024608	MERCEDES	6-10	0509881	1348269	SCANIA	9-5
0508967	6253300603	MERCEDES	6-3	0509893	1094219	VOLVO	10-9
0508968	0003220323	MERCEDES	6-22	0509894	20399543	VOLVO	10-2
0508969	00032207	MERCEDES	6-22	0509895	20375556	VOLVO	10-9
0508998	5010630980	RENAULT V.I.	8-10	0509896	1612254	VOLVO	10-2
0509357	20392778	VOLVO	10-1	0509897	20375555	VOLVO	10-10
0509358	21260275	VOLVO	10-1	0509905	3173613	VOLVO	10-23
0509359	20587731	VOLVO	10-1	0509911	5001868366	RENAULT V.I.	8-3
0509374	7420800194	RENAULT V.I.	8-20	0509911	2082457	VOLVO	10-2
0509391	9703300003	MERCEDES	6-3	0509912	1164684	RENAULT V.I.	8-3
0509411	48510-F3900	NISSAN	7-2	0509914	7420581086	RENAULT V.I.	8-4
0509412	5001868383	RENAULT V.I.	8-10	0509914	20581086	VOLVO	10-3
0509412	20727840	VOLVO	10-8	0509915	2111906	VOLVO	10-23
0509415	81466106813	MAN	5-5	0509916	21260274	VOLVO	10-3
0509416	1393383	SCANIA	9-4	0509939	14066	DAF	2-5
0509417	8146	MAN	5-2	0509941	1401937	DAF	2-5
0509421	504144266	IVECO	4-3	0509943	1403898	DAF	2-5
0509433	7420850454	RENAULT V.I.	8-20	0509946	1395993	DAF	2-6
0509435	5010630434	RENAULT V.I.	8-3	0509947	1395995	DAF	2-6
0509436	22159757	VOLVO	10-1	0509968	85466106162	MAN	5-5
0509437	2136701	VOLVO	10-2	0509982	81466116142	MAN	5-5
0509438	1732973	DAF	2-2	0587871	500383975	IVECO	4-37
0509439	20818854	RENAULT V.I.	8-10	0587990	5000450713	RENAULT V.I.	8-20
0509439	20818854	VOLVO	10-8	0587991	5010253256	RENAULT V.I.	8-20
0509440	7422163636	RENAULT V.I.	8-3	0597871	500383976	IVECO	4-37
0509441	20393089	VOLVO	10-8	0597990	5000450714	RENAULT V.I.	8-20
0509442	9603300403	MERCEDES	6-3	0597991	50102	RENAULT V.I.	8-20
0509449	21119053	VOLVO	10-22	0600516	9983325	IVECO	4-22
0509450	211976	VOLVO	10-22	0602749	2992593	IVECO	4-22
0509451	21146253	VOLVO	10-22	0606927	7820249212	IVECO	4-22
0509452	212097	VOLVO	10-23	0607552	42532977	IVECO	4-22
0509453	3987356	VOLVO	10-23	0609422	42569566	IVECO	4-22
0509459	1828523	DAF	2-5	0709422	5801564293	IVECO	4-32
0509460	5001868385	RENAULT V.I.	8-10	0709423	5801564316	IVECO	4-32
0509460	20727850	VOLVO	10-8	0787249	42551297	IVECO	4-32
0509461	0024608	MERCEDES	6-10	0787250	42551289	IVECO	4-33
0509462	74216	RENAULT V.I.	8-10	0797249	42551296	IVECO	4-33
0509462	21543888	VOLVO	10-9	0797250	42551290	IVECO	4-33
0509463	50103	RENAULT V.I.	8-10	0807207	4714134	IVECO	4-23
0509463	20818840	VOLVO	10-9	0807211	41002770	IVECO	4-23
0509464	1373878	DAF	2-5	0807214	81432206010	MAN	5-8
0509465	22159741	VOLVO	10-9	0807216	8143	MAN	5-8

RIF. OCAP REF. OCAP	RIF. ORIG O.E. NUMBER	MARCA	PAG.	RIF. OCAP REF. OCAP	RIF. ORIG O.E. NUMBER	MARCA	PAG.
0807221	1080690	VOLVO	10-14	0808982	9483502905	MERCEDES	6-18
0807222	1082104	VOLVO	10-14	0808986	94835	MERCEDES	6-18
0807225	41009961	IVECO	4-24	0808987	9743500005	MERCEDES	6-18
0807226	41033731	IVECO	4-24	0809378	20410053	VOLVO	10-16
0807252	5000750976	RENAULT V.I.	8-16	0809381	20491771	VOLVO	10-16
0807262	4200048	IVECO	4-24	0809385	20556491	VOLVO	10-16
0807292	410032	IVECO	4-24	0809386	1628133	VOLVO	10-17
0807295	41011006	IVECO	4-25	0809418	93163964	IVECO	4-28
0807296	41028599	IVECO	4-25	0809420	81432206271	MAN	5-14
0807299	41042093	IVECO	4-25	0809434	1440028	SCANIA	9-8
0807336	98472871	IVECO	4-26	0809443	20448	RENAULT V.I.	8-17
0807358	41009661	IVECO	4-26	0809443	20448089	VOLVO	10-17
0807363	01902137	IVECO	4-26	0809444	9603500906	MERCEDES	6-19
0807372	4121862	IVECO	4-27	0809445	21196798	VOLVO	10-17
0807373	412727	IVECO	4-27	0809446	81432206270	MAN	5-14
0807374	4129673	IVECO	4-27	0809448	41272428	IVECO	4-28
0807407	81432206229	MAN	5-8	0809907	3172829	VOLVO	10-17
0807454	1326775	SCANIA	9-8	0809909	1094466	VOLVO	10-18
0807489	1361651	DAF	2-10	0809917	20374444	VOLVO	10-18
0807501	0267743	DAF	2-10	0809988	81432701601	MAN	5-14
0807525	0649819	DAF	2-10	0903144	504039506 *	IVECO	4-29
0807533	81432706034	MAN	5-9	0907222	1598588	VOLVO	10-14
0807555	1261101	DAF	2-11	0907224	1135080	VOLVO	10-14
0807559	81432206129	MAN	5-8	0907252	5001014345	RENAULT V.I.	8-16
0807579	41011	IVECO	4-28	0907257	0691704	DAF	2-13
0807599	9423500505	MERCEDES	6-15	0907257	271188	VOLVO	10-19
0807611	3953500006	MERCEDES	6-15	0907258	1271124	DAF	2-11
0807634	9423501005	MERCEDES	6-15	0907258	2980884	IVECO	4-23
0807635	9453300007	MERCEDES	6-16	0907258	8143	MAN	5-9
0807636	9413300007	MERCEDES	6-16	0907259	81432206055	MAN	5-10
0807669	8483500106	MERCEDES	6-16	0907259	1104335	SCANIA	9-9
0807687	1581527	VOLVO	10-14	0907262	2983125	IVECO	4-24
0807762	7420829503	RENAULT V.I.	8-16	0907263	5000336305	RENAULT V.I.	8-23
0807762	1076639	VOLVO	10-15	0907264	5000793641	RENAULT V.I.	8-23
0807771	139918	SCANIA	9-8	0907296	1252284	DAF	2-13
0807774	9443500505	MERCEDES	6-16	0907296	93161960	IVECO	4-23
0807807	81432206174	MAN	5-9	0907296	274070	VOLVO	10-19
0807811	81432206067	MAN	5-10	0907297	1376730	DAF	2-13
0807817	8143	MAN	5-10	0907297	9316163	IVECO	4-23
0807820	81432206247	MAN	5-10	0907297	3093469	VOLVO	10-19
0807821	8143	MAN	5-10	0907299	9316163	IVECO	4-26
0807824	8143	MAN	5-11	0907304	42535046	IVECO	4-28
0807839	81432706087	MAN	5-11	0907304	5001842337	RENAULT V.I.	8-18
0807840	81432206221	MAN	5-12	0907304	274068	VOLVO	10-19
0807841	81432706116	MAN	5-12	0907327	93192361	IVECO	4-24
0807842	81432706097	MAN	5-13	0907327	81432306061	MAN	5-15
0807894	81432206229	MAN	5-13	0907330	4249343	IVECO	4-25
0807906	81432206196	MAN	5-13	0907330	00058612	MERCEDES	6-15
0807907	8143	MAN	5-13	0907359	0691709	DAF	2-10
0807908	94835	MERCEDES	6-17	0907359	7420702096	RENAULT V.I.	8-18
0807913	7420741703	RENAULT V.I.	8-17	0907359	20702096	VOLVO	10-14
0807913	20367004	VOLVO	10-15	0907405	81432206202	MAN	5-8
0807927	1294251	DAF	2-11	0907405	81432206202	SCANIA	9-9
0807930	1361652	DAF	2-11	0907407	8543	MAN	5-8
0808738	7421051052	RENAULT V.I.	8-17	0907489	0698724	DAF	2-10
0808738	2052293	VOLVO	10-15	0907525	0696320	DAF	2-10
0808776	1101843	SCANIA	9-8	0907525	81432706080	MAN	5-15
0808975	9453500105	MERCEDES	6-17	0907528	0689748	DAF	2-13

RIF. OCAP - RIF. ORIGINALE - MARCA

CORRISPONDENZE RIFERIMENTI ORIGINALI

Cross Reference Guide - Vergleichenummern List - Liste D'equivalence - Guia De Intercambios

RIF. OCAP REF. OCAP	RIF. ORIG O.E. NUMBER	MARCA	PAG.	RIF. OCAP REF. OCAP	RIF. ORIG O.E. NUMBER	MARCA	PAG.
0907528	81432206244	MAN	5-10	0927436	3895860033	MERCEDES	6-23
0907528	7485104224	RENAULT V.I.	8-18	0927443	5000794320	RENAULT V.I.	8-22
0907528	1102506	SCANIA	9-8	0927444	5000793849	RENAULT V.I.	8-22
0907528	271187	VOLVO	10-16	0927445	5000794319	RENAULT V.I.	8-23
0907529	0696321	DAF	2-11	0927447	5000794318	RENAULT V.I.	8-23
0907529	8143	MAN	5-15	0927452	550713	SCANIA	9-11
0907529	274056	VOLVO	10-17	0927453	550729	SCANIA	9-11
0907533	0005861035	MAN	5-9	0927454	550257	SCANIA	9-11
0907534	81953016133	MAN	5-9	0927458	270912	VOLVO	10-25
0907534	273375	VOLVO	10-20	1215269	93807641	IVECO	4-30
0907547	0003502705	MERCEDES	6-16	1215270	93807640	IVECO	4-30
0907578	93161371	IVECO	4-30	1215271	93810239	IVECO	4-31
0907586	09316137	IVECO	4-30	1215953	504039506	IVECO	4-31
0907591	0003302111	SCANIA	9-8	1216302	8143	MAN	5-18
0907595	0693778	DAF	2-14	1216303	81437040074	MAN	5-18
0907595	5000819413	RENAULT V.I.	8-16	1216304	81437220022	MAN	5-18
0907599	0003502505	MERCEDES	6-15	1216305	81437220021	MAN	5-18
0907609	0003502205	MERCEDES	6-18	1216306	81437040077	MAN	5-18
0907622	00035046	MERCEDES	6-19				
0907634	0003502305	MERCEDES	6-15				
0907635	0003301411	MERCEDES	6-16				
0907683	0696320	DAF	2-14				
0907683	81432706080	MAN	5-16				
0907683	273706	VOLVO	10-14				
0907757	1271124	DAF	2-14				
0907757	-	IVECO	4-23				
0907757	81432206108	MAN	5-9				
0907762	7420840820	RENAULT V.I.	8-16				
0907762	3090712	VOLVO	10-15				
0907763	7420840815	RENAULT V.I.	8-16				
0907763	20840815	VOLVO	10-15				
0907774	0003502405	IVECO	4-27				
0907774	81432706110	MAN	5-11				
0907774	00035049	MERCEDES	6-17				
0907820	81432206322	MAN	5-10				
0907840	81432706118	MAN	5-12				
0907907	8143	MAN	5-11				
0907908	0003503605	MERCEDES	6-17				
0907909	0003503705	MERCEDES	6-17				
0907919	7420547286	RENAULT V.I.	8-17				
0907919	20547286	VOLVO	10-15				
0907927	1321936	DAF	2-11				
0907927	93163617	IVECO	4-30				
0907984	00035047	MERCEDES	6-21				
0908991	0003502305	MERCEDES	6-21				
0909379	1075255	VOLVO	10-16				
0909380	1628107	VOLVO	10-16				
0909422	5801564274	IVECO	4-30				
0909434	1444472	SCANIA	9-8				
0909909	3090452	VOLVO	10-16				
0909992	81432206285	MAN	5-14				
0909994	7420702095	RENAULT V.I.	8-17				
0909994	20702095	VOLVO	10-15				
0927365	4676168	IVECO	4-39				
0927383	4596193	IVECO	4-39				
0927387	15540921	IVECO	4-39				
0927388	15540921	IVECO	4-40				
0927391	7173052	IVECO	4-40				

